

MIS-INSTRUMENTS LAP-INSTRUMENTE

modular and integral
laparoscopic instruments
modulare und integrale
Laparoskopie-Instrumente



BEMA MEDICAL the company

Solutions. Not compromises.

The smallest details make all the difference in life. Users of laparoscopy are very aware of this. As a purchaser and decision-maker, you know this. This is why details are our main focus at BEMA. Details that make a huge difference in terms of ergonomics, versatility, economy and quality.

Today we are both nationally and internationally recognized partners for minimally invasive instruments complying with EN ISO 13485 norms. Developed through practice for practices! Always highly individualized and with modular systems for even more flexibility in applications and processes.

Our products are based on what your specific needs are. We have developed our own patented modular tube shaft system mainly for use in laparoscopy. The result: instruments that are not the benchmarks for competitors – but much more: for people! Welcome to BEMA!

Your focus is on people. Our focus is on the details.

Let us give you some insight into this fascinating field!

And in case you'd like to know more: just ask us!

BEMA – if it's quality that you expect!

Lösungen. Keine Kompromisse.

Feinste Details entscheiden im Leben. Und: über das Leben. Das wissen Anwender in der Laparoskopie. Das wissen Sie als Einkäufer und Entscheider. Deshalb konzentrieren wir bei BEMA uns auf Details. Auf Details, die den Unterschied machen. Hinsichtlich Ergonomie, Vielseitigkeit, Wirtschaftlichkeit – und Qualität.

Heute sind wir national und international geschätzter Partner für minimalinvasive Instrumente nach EN ISO 13485. Aus der Praxis. Für die Praxis! Immer hoch individuell. Mit Baukastensystemen für noch mehr Flexibilität in Anwendungen und Abläufen.

Unsere Basis: Ihre besonderen Ansprüche. Unser selbst entwickeltes und urheberrechtlich geschütztes modulares Rohrchaftsystem für den Hauptbereich Laparoskopie. Das Ergebnis: Instrumente, die nicht die Mitbewerber zum Maßstab haben – sondern weit mehr: den Menschen! Herzlich willkommen bei BEMA!

Sie haben den Menschen im Blick. Wir die Details.

Wir geben Ihnen Einblick – auf den folgenden Seiten!

Und wenn Sie noch mehr wissen wollen: Fragen Sie uns!

BEMA – wenn es Qualität ist, was Sie erwarten!



Thomas Becker -
Business manager, founder and owner.
Your partner for all inquiries!

BEMA GmbH + Co. KG · Rudolf-Diesel-Str. 12 · D-78576 Emmingen/Germany
phone: ++49 (0)7465-9299-0 · fax: ++49 (0)7465-9299-29
website: www.bemamedical.com · e-mail: mail@bemamedical.com

MINIMALLY INVASIVE SURGERY - INDEX

DISCRIPTION **page**

modular laparoscopy instruments:

<i>modular handles for 2- and 3-part system</i>	4
<i>modular 2-part Ø 3 mm system - how to order a complete instrument (set)</i>	9
<i>modular 2-part Ø 3 mm system - assembly and disassembly</i>	10
<i>modular 2-part Ø 3 mm system - working parts.</i>	12
<i>modular 3-part Ø 5 and 10 mm systems - how to order a complete instrument (set)</i>	19
<i>modular 3-part Ø 5 and 10 mm systems - assembly and disassembly</i>	20
<i>modular 3-part Ø 5 mm system - tube shafts</i>	23
<i>modular 3-part Ø 5 mm system - inserts</i>	24
<i>modular 3-part Ø 10 mm system - tube shafts</i>	49
<i>modular 3-part Ø 10 mm system - inserts.</i>	50

integral laparoscopy instruments:

<i>integral Ø 3 and 5 mm instruments - needle holders</i>	54
<i>integral Ø 5 mm instruments - slide lock graspers</i>	64
<i>integral Ø 5 and 10 mm instruments - fan retractors</i>	66
<i>integral Ø 5 mm instruments - cholangiography fixation clamps</i>	68



ANGLED HIGHLY RIGID PLASTIC HANDLE

Ergonomic ring handles with rotation module,
available with or without HF connection

Art No. for Set Art.-Nr. für Set	Art. No. for single part Art.-Nr. für Einzelteil	Description Beschreibung
80	300-100-0080	with HF-connection mit HF-Anschluss
180	300-100-0180	without HF-connection ohne HF-Anschluss

| stepless ratchet, ratchet deactivable, release key
| stufenlose Sperre, Sperre deaktivierbar, Entriegelungstaste

ABGEWINKELTE KUNSTSTOFFGRIFFE

Ergonomische Ringgriffe mit Rotationsmodul,
erhältlich mit oder ohne HF-Anschluss

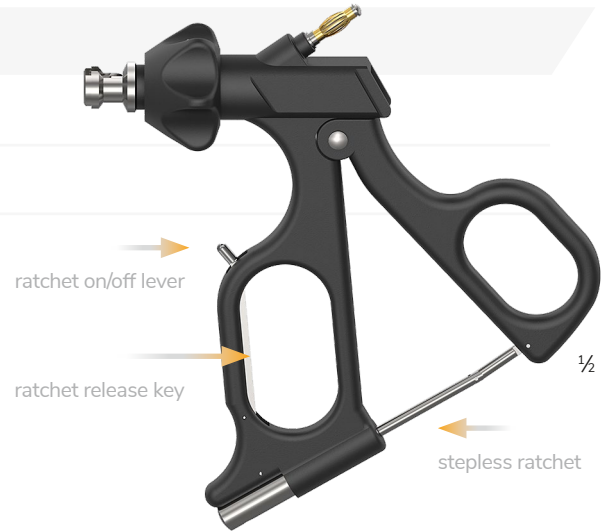

Art No. for Set Art.-Nr. für Set	Art. No. for single part Art.-Nr. für Einzelteil	Description Beschreibung
81	300-100-0081	with HF-connection mit HF-Anschluss
181	300-100-0181	without HF-connection ohne HF-Anschluss

| stepless ratchet, release key
| stufenlose Sperre, Entriegelungstaste



Art No. for Set Art.-Nr. für Set	Art. No. for single part Art.-Nr. für Einzelteil	Description Beschreibung
82	300-100-0082	with HF-connection mit HF-Anschluss
182	300-100-0182	without HF-connection ohne HF-Anschluss

| fold-out ratchet, ratchet deactivable
| ausklappbare Sperre, Sperre deaktivierbar





ANGLED HIGHLY RIGID PLASTIC HANDLE

Ergonomic ring handles with rotation module,
 available with or without HF connection

ABGEWINKELTE KUNSTSTOFFGRIFFE

Ergonomische Ringgriffe mit Rotationsmodul,
 erhältlich mit oder ohne HF-Anschluss

Art No. for Set Art-Nr. für Set	Art. No. for single part Art.-Nr. für Einzelteil	Description Beschreibung
84	300-100-0084	with HF-connection mit HF-Anschluss
184	300-100-0184	without HF-connection ohne HF-Anschluss



Art No. for Set Art-Nr. für Set	Art. No. for single part Art.-Nr. für Einzelteil	Description Beschreibung
85	300-100-0085	with HF-connection mit HF-Anschluss
185	300-100-0185	without HF-connection ohne HF-Anschluss



ratchet deactivable, release key
 Sperre deaktivierbar, Entriegelungstaste

ratchet release key

deactivate ratchet button



AXIAL HANDLES

AXIALGRIFFE

Art No. for Set Art-Nr. für Set	Art. No. for single part Art.-Nr. für Einzelteil
50	300-100-0050

| Axial handle with rings and ratchet
 | Axialgriff mit Ringen und Sperre



Art No. for Set Art-Nr. für Set	Art. No. for single part Art.-Nr. für Einzelteil
52	300-100-0052

| Axial handle with rings
 | Axialgriff mit Ringen



Art No. for Set Art-Nr. für Set	Art. No. for single part Art.-Nr. für Einzelteil
60	300-100-0060

| Axial handle with spreading spring and ratchet
 | Axialgriff mit Spreizfeder und Sperre

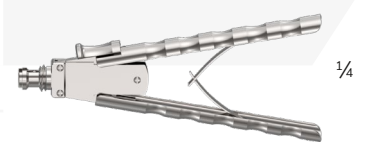

Art No. for Set Art-Nr. für Set	Art. No. for single part Art.-Nr. für Einzelteil
62	300-100-0062

| Axial handle with spreading spring
 | Axialgriff mit Spreizfeder

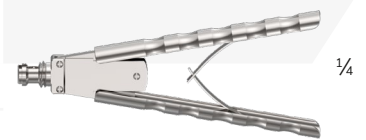

Art No. for Set Art-Nr. für Set	Art. No. for single part Art.-Nr. für Einzelteil
70	300-100-0070

| Axial handle angled with spreading spring and ratchet
 | Axialgriff gewinkelt mit Spreizfeder und Sperre



Art No. for Set Art-Nr. für Set	Art. No. for single part Art.-Nr. für Einzelteil
72	300-100-0072

| Axial handle angled with spreading spring
 | Axialgriff gewinkelt mit Spreizfeder



Full compatibility in the BEMA system!
All handles fit all tube shafts.

Volle Kompatibilität im BEMA-System!
Alle Griffe passen zu allen Rohrschäften.

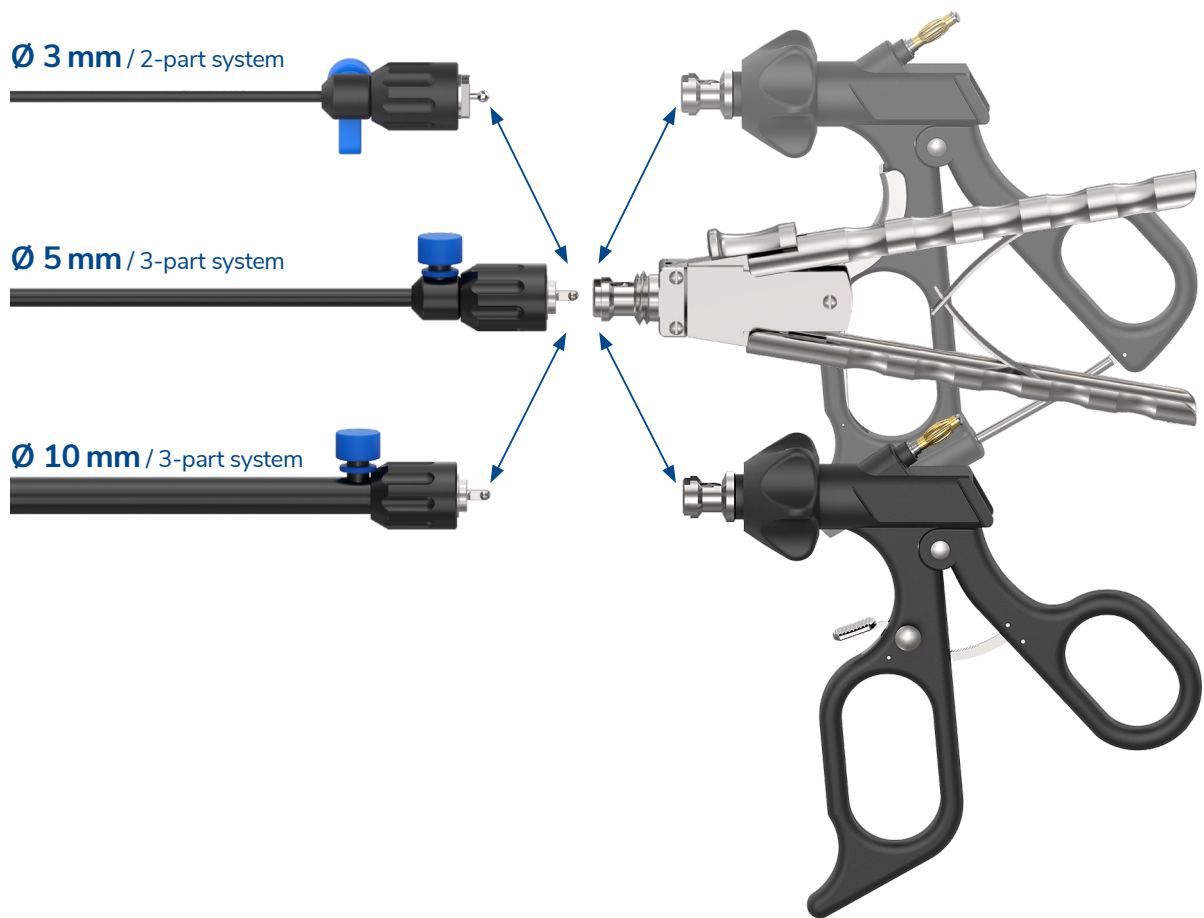

LAPAROSCOPY INSTRUMENTS Ø 3 mm

LAPAROSKOPIE-INSTRUMENTE Ø 3 mm



2-part system (modular)

With or without flushing connection

Available in three working lengths

Can be ordered as single parts or as a set

2-teiliges System (modular)

Mit oder ohne Spülanschluss

In drei Arbeitslängen erhältlich

Bestellbar als einzelne Teile oder als Set



HOW TO ORDER A SET

Order your individual set by compiling the correct item number like this:

XXX - LL 03 - (1)YY

1. Jaw type:

Art No. for Set

2. Working Length

18 for 18 cm
 21 for 21 cm
 33 for 33 cm

3. MIS-Instrument:

03 for Ø3 mm
 2-part system

4. Handle:

Art No. for Set
 (optional) supplement with **1**
 means without HF-connection

1. Maultyp:

Art-Nr. für Set

2. Arbeitslänge:

18 für 18 cm
 21 für 21 cm
 33 für 33 cm

3. LAP-Instrument:

03 für Ø3 mm
 2-teiliges System

4. Griff:

Art-Nr. für Set
 (wahlweise) ergänzen mit **1**
 bedeutet ohne HF-Anschluss

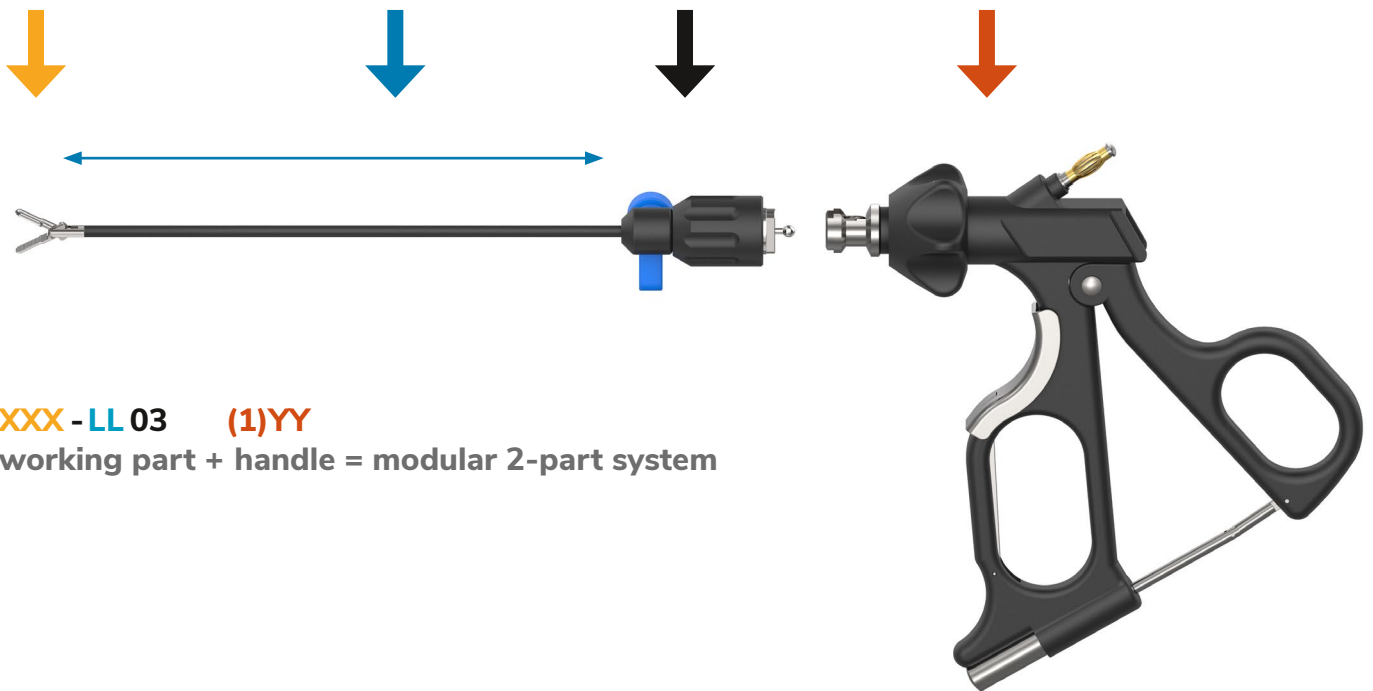

XXX - LL 03 (1)YY
 working part + handle = modular 2-part system

EXAMPLES

With HF-connection:

- ▶ XXX (Art No.) = 214
- ▶ LL (Length) = 18 (18 cm)
- ▶ 03 (Ø3 mm) = 03
- ▶ YY (Handle No.) = 84

Art No. =

214 - 18 03 - 84

Without HF-connection:

- ▶ XXX (Art No.) = 214
- ▶ LL (Length) = 21 (21 cm)
- ▶ 03 (Ø3 mm) = 03
- ▶ YYY (Handle No.) = 184

Art No. =

214 - 21 03 - 184

BEISPIELE

Mit HF-Anschluss:

- ▶ XXX (Insert Nr.) = 214
- ▶ LL (Länge) = 18 (18 cm)
- ▶ 03 (Ø3 mm) = 03
- ▶ YY (Griff Nr.) = 84

Art.-Nr. =

214 - 18 03 - 84

Ohne HF-Anschluss:

- ▶ XXX (insert Nr.) = 214
- ▶ LL (Länge) = 21 (21 cm)
- ▶ 03 (Ø3 mm) = 03
- ▶ YYY (Griff Nr.) = 184

Art.-Nr. =

214 - 21 03 - 184



ASSEMBLING

| 2-part system (modular), shaft-Ø 3 mm

MONTAGE

| 2-teiliges System (modular), Schaft-Ø 3 mm

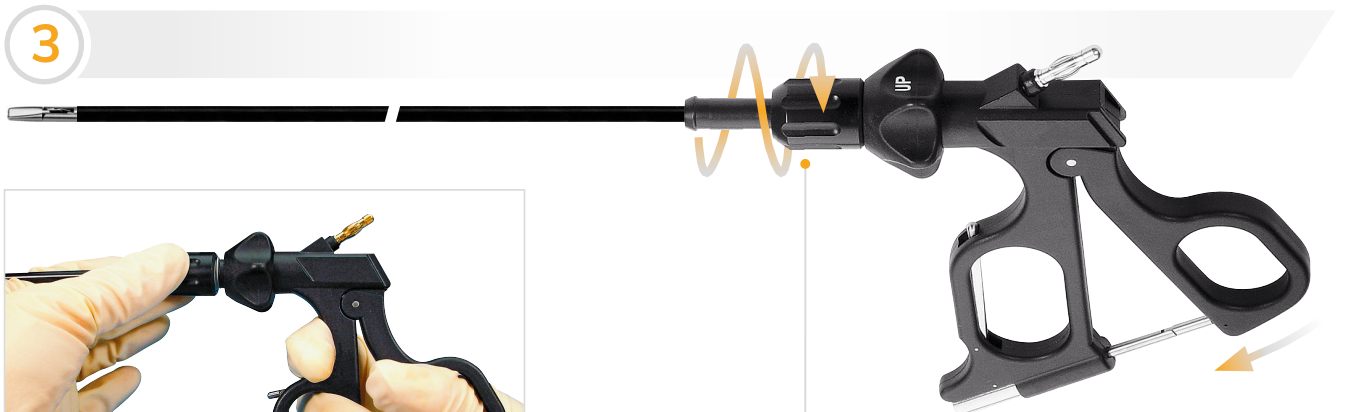
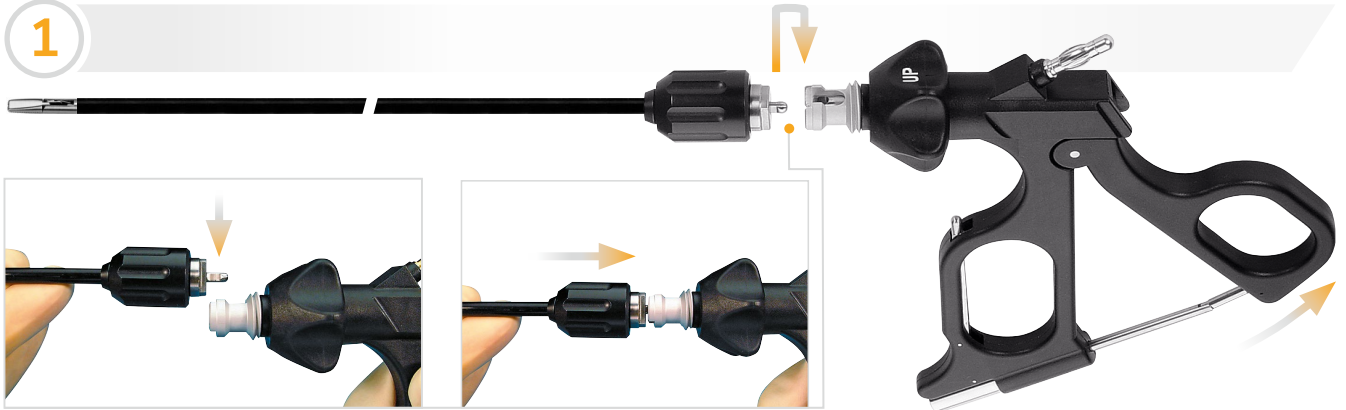



DISASSEMBLING

| 2-part system (modular), shaft-Ø 3 mm

DEMONTAGE



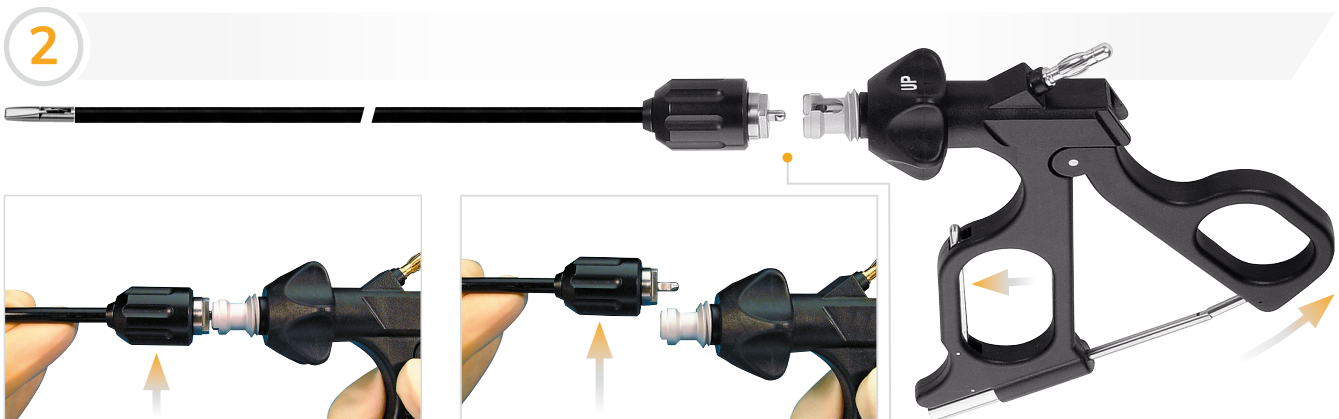
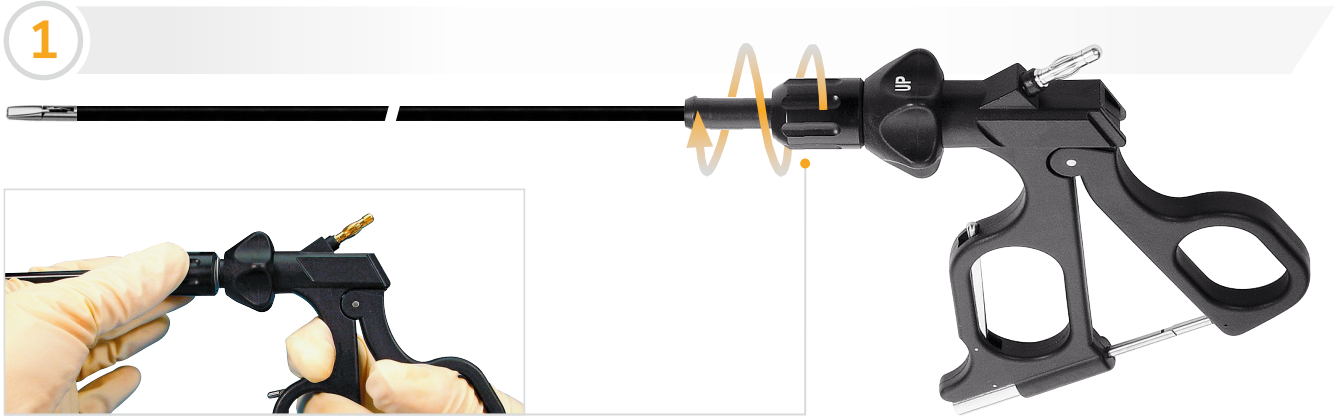



| 2-teiliges System (modular) , Schaft-Ø 3 mm





FORCEPS Ø 3 mm







GREIFER Ø 3 mm

	Art No. for Set Art.-Nr. für Set	Art No. for single part Art.-Nr. für Einzelteil	Description Beschreibung
	209	300-209-1803 (18 cm) 300-209-2103 (21 cm) 300-209-3303 (33 cm)	Universal grasping forceps, jaw length 16 mm, double action jaws Universal-Fasszange, Maullänge 16 mm, doppelbeweglich
	210	300-210-1803 (18 cm) 300-210-2103 (21 cm) 300-210-3303 (33 cm)	Universal grasping forceps, jaw length 9 mm, double action jaws Universal-Fasszange, Maullänge 9 mm, doppelbeweglich
	212	300-212-1803 (18 cm) 300-212-2103 (21 cm) 300-212-3303 (33 cm)	MARYLAND grasping forceps, double action jaws MARYLAND Fasszange, doppelbeweglich
	213	300-213-1803 (18 cm) 300-213-2103 (21 cm) 300-213-3303 (33 cm)	Dissecting forceps, fenestrated, double action jaws Dissektions-Fasszange, gefenstert, doppelbeweglich
	214	300-214-1803 (18 cm) 300-214-2103 (21 cm) 300-214-3303 (33 cm)	Dissecting forceps, fenestrated, curved, double action jaws Dissektions-Fasszange, gefenstert, gebogen, doppelbeweglich
	220	300-220-1803 (18 cm) 300-220-2103 (21 cm) 300-220-3303 (33 cm)	Grasping forceps with reservoir, blunt, double action jaws Fasszange mit Reservoir, stumpf, doppelbeweglich
	222	300-222-1803 (18 cm) 300-222-2103 (21 cm) 300-222-3303 (33 cm)	Grasping forceps with reservoir, sharp, double action jaws Fasszange mit Reservoir, scharf, doppelbeweglich



FORCEPS Ø 3 mm







GREIFER Ø 3 mm

	Art No. for Set Art-Nr. für Set	Art No. for single part Art.-Nr. für Einzelteil	Description Beschreibung
	224	300-224-1803 (18 cm) 300-224-2103 (21 cm) 300-224-3303 (33 cm)	Grasping forceps "Dolphin", double action jaws Fasszange „Delphin“, doppelbeweglich
	227	300-227-1803 (18 cm) 300-227-2103 (21 cm) 300-227-3303 (33 cm)	MARYLAND grasping forceps, crosswise teeth, long, double action jaws MARYLAND Fasszange, kreuzverzahnt, lang, doppelbeweglich
	230	300-230-1803 (18 cm) 300-230-2103 (21 cm) 300-230-3303 (33 cm)	Grasping forceps sharp, crosswise teeth, jaw length 12 mm, double action jaws Fasszange scharf, Kreuzverzahnung, Maullänge 12 mm, doppelbeweglich
	242	300-242-1803 (18 cm) 300-242-2103 (21 cm) 300-242-3303 (33 cm)	Claw grasping and extracting forceps, 2+3 teeth, single action jaws Krallengreifzange, 2+3 Zähne, einfachbeweglich
	246	300-246-1803 (18 cm) 300-246-2103 (21 cm) 300-246-3303 (33 cm)	Extracting forceps with a row of retrograde teeth, double action jaws Extraktionszange, retrograde Zahnreihe, doppelbeweglich
	258	300-258-1803 (18 cm) 300-258-2103 (21 cm) 300-258-3303 (33 cm)	MIXTER grasping forceps, 90° gewinkelt, double action jaws MIXTER Fasszange, 90° angled, doppelbeweglich
	261	300-261-1803 (18 cm) 300-261-2103 (21 cm) 300-261-3303 (33 cm)	JOHANN Dissecting and grasping forceps, double action jaws JOHANN Präparier- und Fasszange, doppelbeweglich



FORCEPS Ø 3 mm



GREIFER Ø 3 mm

	Art No. for Set Art.-Nr. für Set	Art No. for single part Art.-Nr. für Einzelteil	Description Beschreibung
	266	300-266-1803 (18 cm) 300-266-2103 (21 cm) 300-266-3303 (33 cm)	KELLY Dissector, double action jaws KELLY Dissektor, doppelbeweglich
	267	300-267-1803 (18 cm) 300-267-2103 (21 cm) 300-267-3303 (33 cm)	JOHANN dissecting and grasping forceps, fenestrated, single action jaws JOHANN Präparier- und Fasszange, gefenstert, einfachbeweglich
	270	300-270-1803 (18 cm) 300-270-2103 (21 cm) 300-270-3303 (33 cm)	BABCOCK clamp, fenestrated, double action jaws BABCOCK Klemme, gefenstert, doppelbeweglich
	284	300-284-1803 (18 cm) 300-284-2103 (21 cm) 300-284-3303 (33 cm)	Tenaculum grasping forceps, double action jaws Tenakulum-Fasszange, doppelbeweglich
	293	300-293-1803 (18 cm) 300-293-2103 (21 cm) 300-293-3303 (33 cm)	Atraumatic grasping forceps, with wavy teeth and reservoir, single action jaws Atraumatische Fasszange mit gewellten Zähnen und Reservoir, einfachbeweglich
	520	300-520-1803 (18 cm) 300-520-2103 (21 cm) 300-520-3303 (33 cm)	DeBAKEY grasping forceps, double action jaws DeBAKEY Fasszange, doppelbeweglich
	542	300-542-1803 (18 cm) 300-542-2103 (21 cm) 300-542-3303 (33 cm)	ALLIS grasping forceps, double action jaws ALLIS Fasszange, doppelbeweglich



BIOPSY CUPS Ø 3 mm

BIOPSIE LÖFFEL Ø 3 mm

Art No. for Set Art-Nr. für Set	Art No. for single part Art.-Nr. für Einzelteil	Description Beschreibung
 1/4	310 300-310-1803 (18 cm) 300-310-2103 (21 cm) 300-310-3303 (33 cm)	Biopsy cup without thorn, double action jaws Biopsie-Löffel ohne Dorn, doppelbeweglich
 1/4	312 300-312-1803 (18 cm) 300-312-2103 (21 cm) 300-312-3303 (33 cm)	Biopsy cup with thorn, double action jaws Biopsie-Löffel mit Dorn, doppelbeweglich



... if it's quality that you expect!

MODULAR SYSTEM

Can be ordered in 3 different lengths.

MODULARES SYSTEM

In 3 verschiedenen Längen bestellbar.



MICROLAP Ø 3 mm

Each insert is available in three working lengths and with flushing connection.

MICROLAP Ø 3 mm



Jeder Aufsatz ist in drei Arbeitslängen und mit Spülanschluss verfügbar

SCISSORS Ø 3 mm

Scissors sets can only be ordered with handle no. 52, 62,84 und 184.

SCHEREN Ø 3 mm

Scheren-Sets können nur für die Griffe Nr. 52, 62,84 und 184 bestellt werden.

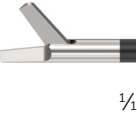
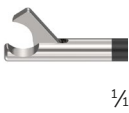
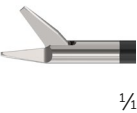
	Art No. for Set Art-Nr. für Set	Art No. for single part Art.-Nr. für Einzelteil	Description Beschreibung
	110	300-110-1803 (18 cm)	Preparation scissors, double action jaws Präparier-Schere, doppelbeweglich
		300-110-2103 (21 cm)	
		300-110-3303 (33 cm)	
	112	300-112-1803 (18 cm)	METZENBAUM preparation scissors, curved, double action jaws METZENBAUM Präparier-Schere, gebogen, doppelbeweglich
		300-112-2103 (21 cm)	
		300-112-3303 (33 cm)	
	114	300-114-1803 (18 cm)	Micro peritoneal scissors, single action jaws Mikro-Peritonalschere, einfachbeweglich
		300-114-2103 (21 cm)	
		300-114-3303 (33 cm)	
	116	300-116-1803 (18 cm)	Hook scissors, single action jaws Hakenschere, einfachbeweglich
		300-116-2103 (21 cm)	
		300-116-3303 (33 cm)	
	118	300-118-1803 (18 cm)	Micro scissors, single action jaws Micro-Schere, einfachbeweglich
		300-118-2103 (21 cm)	
		300-118-3303 (33 cm)	







NEEDLE HOLDERS Ø 3 mm

Needle holders sets can only be ordered with
 handle no. 50, 60, 70, 180, 181, 182 and 185.

NADELHALTER Ø 3 mm

Nadelhalter-Sets können nur für die Griffe Nr. 50, 60, 70,
 180, 181, 182 und 185 bestellt werden.

	Art No. for Set Art-Nr. für Set	Art No. for single part Art-Nr. für Einzelteil	Description Beschreibung
	350	300-350-1803 (18 cm) 300-350-2103 (21 cm) 300-350-3303 (33 cm)	Straight with TC insert, crosswise teeth, single action jaws Gerade mit Hartmetalleinlagen, kreuzverzahnt, einfachbeweglich
	352	300-352-1803 (18 cm) 300-352-2103 (21 cm) 300-352-3303 (33 cm)	Left curved with TC insert, crosswise teeth, single action jaws Links gebogen mit Hartmetalleinlagen, kreuzverzahnt, einfachbeweglich
	354	300-354-1803 (18 cm) 300-354-2103 (21 cm) 300-354-3303 (33 cm)	Right curved with TC insert, crosswise teeth, single action jaws Rechts gebogen mit Hartmetalleinlagen, kreuzverzahnt, einfachbeweglich
	360	300-360-1803 (18 cm) 300-360-2103 (21 cm) 300-360-3303 (33 cm)	Needle holder/-positioner, convex/concave shaped jaws with fixation teeth, with wolfram-carbide-coated tips, single action jaws Nadelhalter -positionierer, konvex/konvav geformte Maulform mit Fixierzähnen, Greifflächen mit Wolfram-Karbid-Beschichtung, einfachbeweglich



LAPAROSCOPY INSTRUMENTS Ø 5 mm

LAPAROSKOPIE-INSTRUMENTE Ø 5 mm



3-part system (modular)

With or without flushing connection

Available in four working lengths

Ø 10 mm tube shafts available for Ø 5 mm inserts

Can be ordered as single parts or as a set

3-teiliges System (modular)

Mit oder ohne Spülanschluss

In vier Arbeitslängen erhältlich

Ø 10 mm Rohrschäfte für Ø 5 mm Einsätze erhältlich

Bestellbar als einzelne Teile oder als Set



HOW TO ORDER A SET

Order your individual set by compiling the correct item number like this:

EIN SET BESTELLEN

Um ihr individuelles Set zu bestellen setzen Sie die Artikelnummer wie folgt zusammen:

XXX - LL XX (L) - (1)YY

1. Jaw / Insert: Art No. for Set	2. Working Length: 25 for 25 cm 33 for 33 cm 36 for 36 cm 45 for 45 cm	3. MIS-Instrument: 05 for Ø 5 mm resp. 10 for Ø 10 mm 3-part system	4. flushing-connection: (optional) Supplement L for flushing-connection	5. Handle: Art No. for Set (optional) Supplement with 1 means without HF-connection
--	---	--	---	--

1. Maul / Einsatz: Art-Nr. für Set	2. Arbeitslänge: 25 für 25 cm 33 für 33 cm 36 für 36 cm 45 für 45 cm	3. LAP-Instrument: 05 für Ø 5 mm bzw. 10 für Ø 10 mm 3-teiliges System	4. Spülanschluss: (wahlweise) Ergänzen mit L für Spülanschluss	5. Griff: Art-Nr. für Set (wahlweise) Ergänzen mit 1 bedeutet ohne HF-Anschluss
--	---	---	--	--

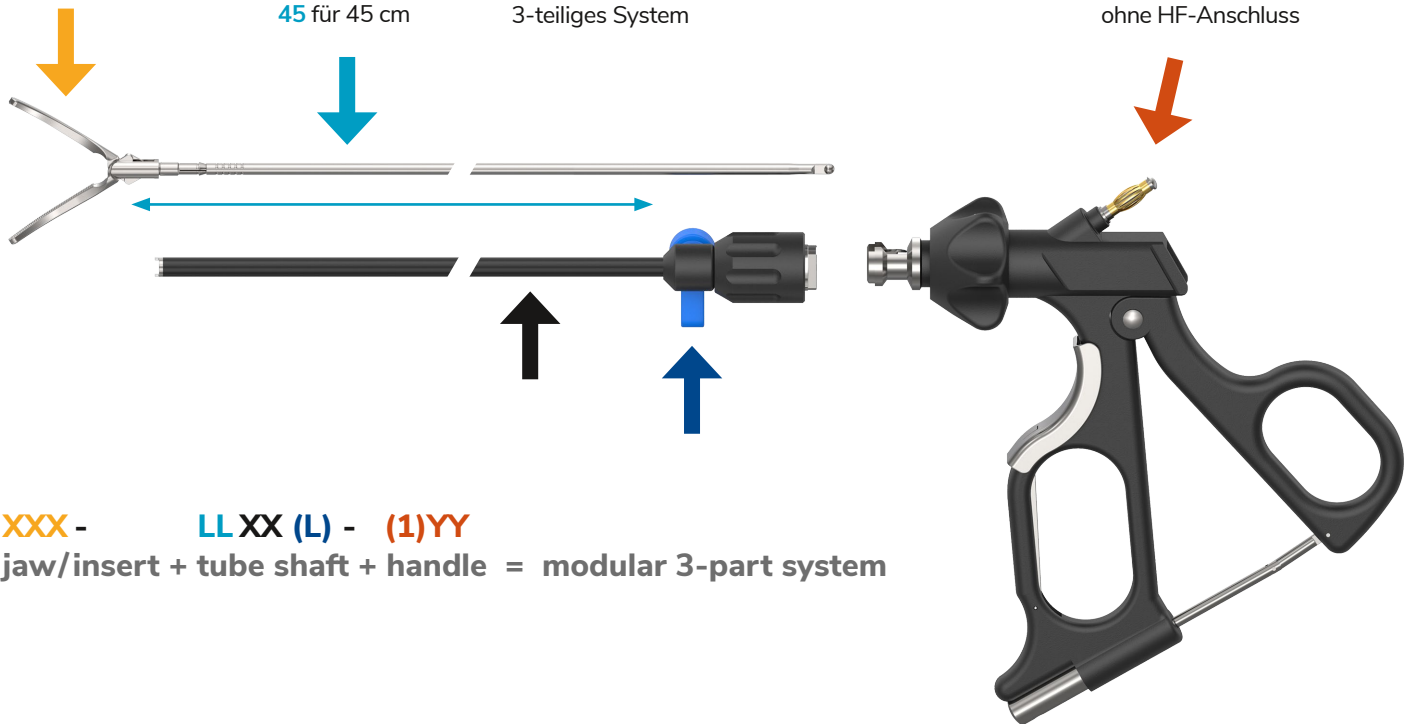

XXX - LLXX (L) - (1)YY
 jaw/insert + tube shaft + handle = modular 3-part system

EXAMPLES

With HF-connection,
with flushing connection:

- ▶ XXX (Art No.) = 286
- ▶ LL (Length) = 33 (33 cm)
- ▶ 05 (Ø5 mm) = 05
- ▶ L (flushing con.) = L
- ▶ YY (Handle No.) = 84

Art No. =
286 - 33XXL - 84

Without HF-connection,
without flushing connection:

- ▶ XXX (Art No.) = 286
- ▶ LL (Length) = 36 (36 cm)
- ▶ 05 (Ø5 mm) = 05
- ▶ YYY (Handle No.) = 184

Art No. =
286 - 36XX - 184

BEISPIELE

Mit HF-Anschluss,
mit Spülanschluss:

- ▶ XXX (Art-Nr.) = 286
- ▶ LL (Länge) = 33 (33 cm)
- ▶ 05 (Ø5 mm) = 05
- ▶ L (Spülanschluss) = L
- ▶ YY (Griff Nr.) = 84

Art.-Nr. =
286 - 33XXL - 84

Ohne HF-Anschluss,
ohne Spülanschluss:

- ▶ XXX (Art-Nr.) = 286
- ▶ LL (Länge) = 36 (36 cm)
- ▶ 05 (Ø5 mm) = 05
- ▶ YYY (Griff Nr.) = 184

Art.-Nr. =
286 - 36XX - 184



ASSEMBLING

| 3-part system (modular), shaft-Ø 5 und 10 mm

MONTAGE

| 3-teiliges System (modular), Schaft-Ø 5 und 10 mm

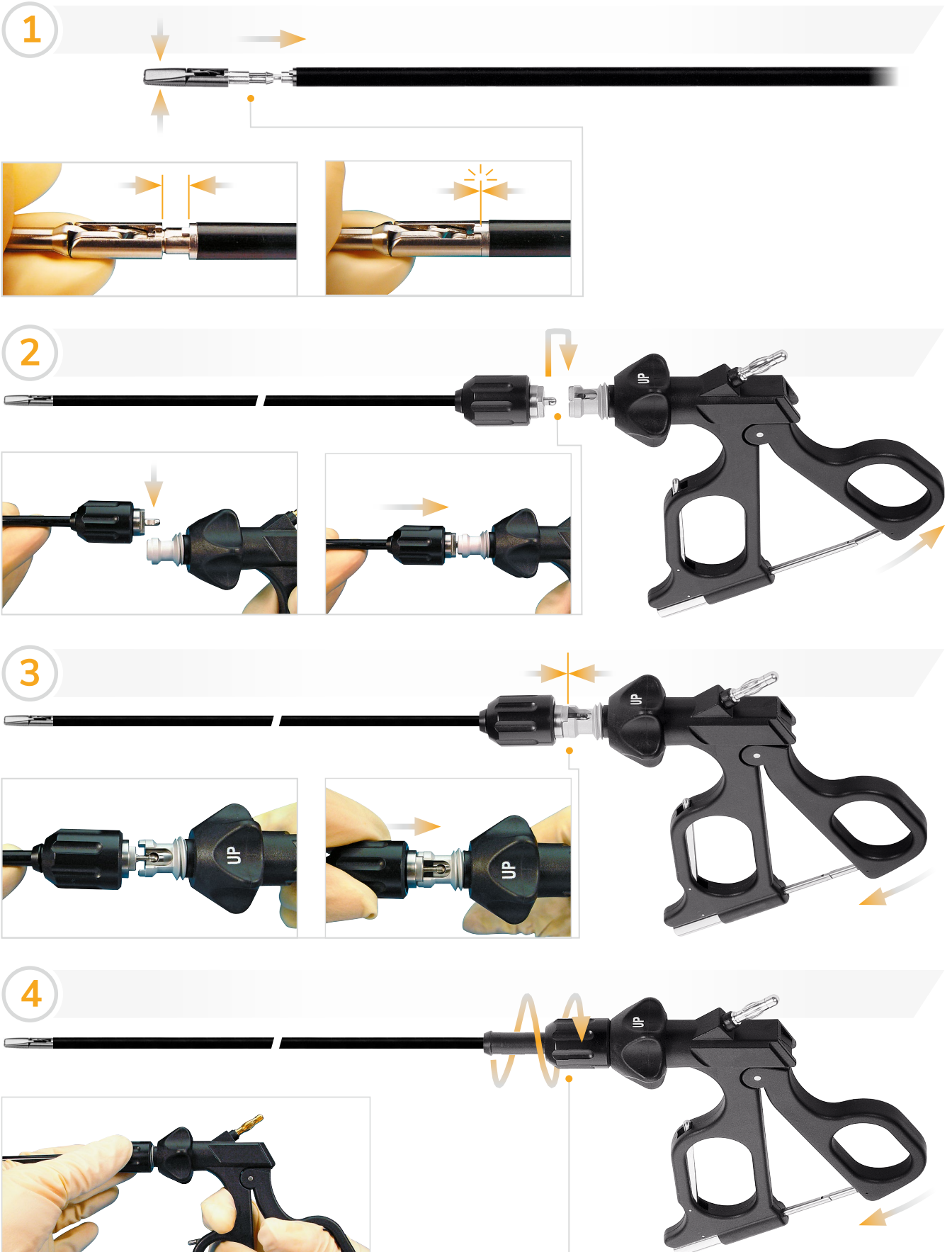



DISASSEMBLING

3-part system (modular), shaft-Ø 5 und 10 mm

DEMONTAGE

3-teiliges System (modular) Schaft-Ø 5 und 10 mm

1

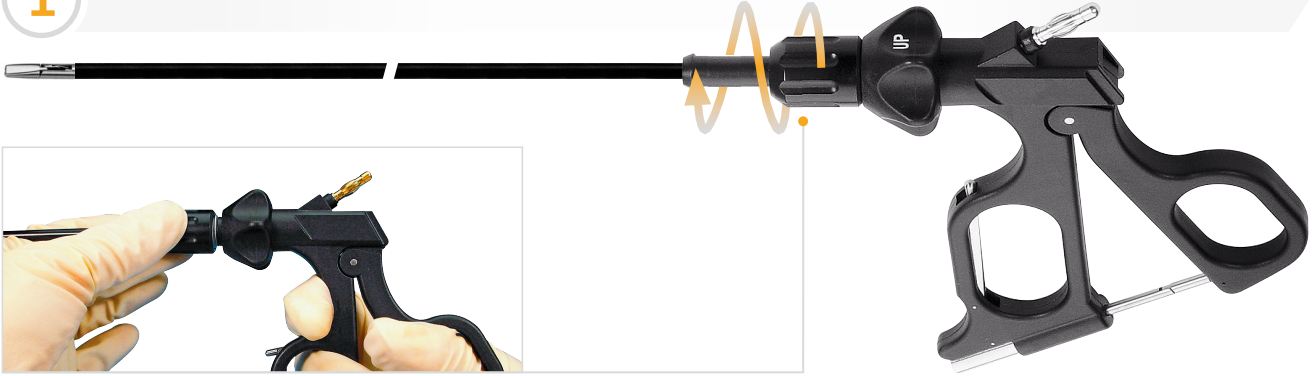

2

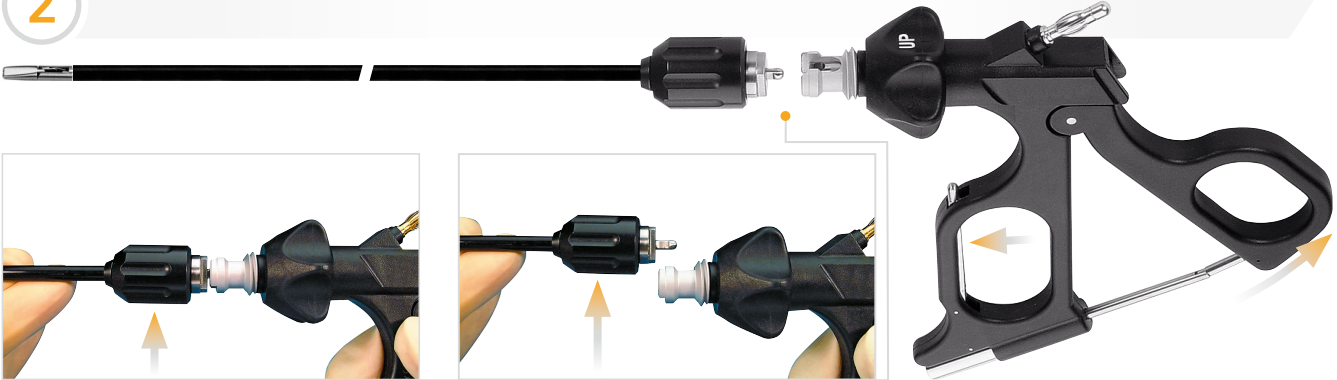

3

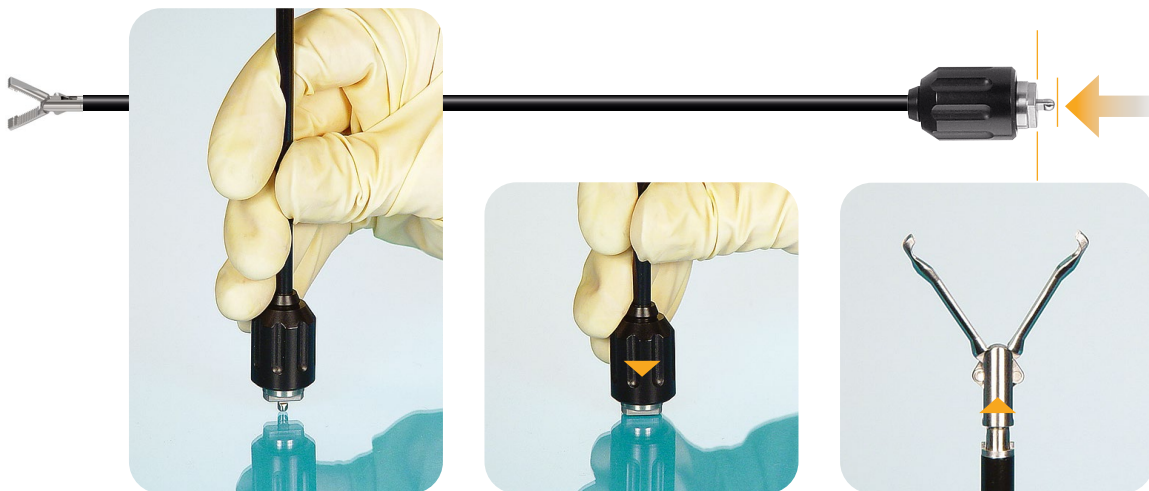

4





MODULAR TUBE SHAFTS

Available in four working lengths,
with or without flushing connection.

MODULARE ROHRSCHÄFTE

In vier Arbeitslängen, mit
oder ohne Spülanschluss
erhältlich.





TUBE SHAFTS Ø 5 mm

ROHRSCHÄFTE Ø 5 mm

Working Length Arbeitslänge	Art No. for single part Art.-Nr. für Einzelteil	Description Beschreibung
25 cm	300-100-2505	
33 cm	300-100-3305	without flushing connection
36 cm	300-100-3605	ohne Spülanschluss
45 cm	300-100-4505	
25 cm	300-100-2505L	
33 cm	300-100-3305L	with flushing connection
36 cm	300-100-3605L	mit Spülanschluss
45 cm	300-100-4505L	



TUBE SHAFTS Ø 10 mm REDUCED TO Ø 5 mm

ROHRSCHÄFTE Ø 10 mm REDUZIERT AUF Ø 5 mm

Working Length Arbeitslänge	Art No. for single part Art.-Nr. für Einzelteil	Description Beschreibung
33 cm	300-100-3310-5	
36 cm	300-100-3610-5	without flushing connection
45 cm	300-100-4510-5	ohne Spülanschluss
33 cm	300-100-3310-5L	
36 cm	300-100-3610-5L	with flushing connection
45 cm	300-100-4510-5L	mit Spülanschluss





INSERTS Ø 5 mm

LL = Length = 25 cm, 33 cm, 36 cm, 45 cm
 (Each insert is available in four working lengths)

EINSÄTZE Ø 5 mm



LL = Länge = 25 cm, 33 cm, 36 cm, 45 cm
 (Jeder Einsatz ist in vier Arbeitslängen verfügbar.)

SCISSORS Ø 5 mm

Scissors sets can only be ordered with
 handle no. 52, 62, 84 und 184.

SCHEREN Ø 5 mm

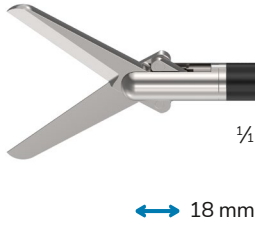
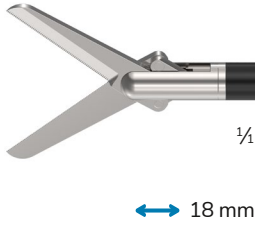
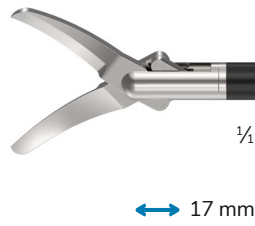
Scheren-Sets können nur für die Griffe Nr. 52, 62, 84 und
 184 bestellt werden.

	Art No. for Set Art.-Nr. für Set	Art No. for single part Art.-Nr. für Einzelteil	Description Beschreibung
 <p>1/1 ↔ 18 mm</p>	110	300-110-2505 (25 cm) 300-110-3305 (33 cm) 300-110-3605 (36 cm) 300-110-4505 (45 cm)	Preparation scissors, double action jaws Präparier-Schere, doppelbeweglich
 <p>1/1 ↔ 18 mm</p>	111	300-111-2505 (25 cm) 300-111-3305 (33 cm) 300-111-3605 (36 cm) 300-111-4505 (45 cm)	Endo scissors "Supercut", serrated, double action jaws Endo-Schere „Supercut“, fein gezahnt, doppelbeweglich
 <p>1/1 ↔ 17 mm</p>	112	300-112-2505 (25 cm) 300-112-3305 (33 cm) 300-112-3605 (36 cm) 300-112-4505 (45 cm)	METZENBAUM Scissors, curved, double action jaws METZENBAUM-Schere, gebogen, doppelbeweglich
 <p>1/1 ↔ 20 mm</p>	113	300-113-2505 (25 cm) 300-113-3305 (33 cm) 300-113-3605 (36 cm) 300-113-4505 (45 cm)	METZENBAUM Scissors "Wondercut", curved, double action jaws METZENBAUM-Schere „Wondercut“, gebogen, doppelbeweglich







SCISSORS Ø 5 mm

Scissors sets can only be ordered with
handle no. 52, 62, 84 und 184.

SCHEREN Ø 5 mm

Scheren-Sets können nur für die **Griffe Nr. 52, 62, 84 und 184** bestellt werden.

	Art No. for Set Art-Nr. für Set	Art No. for single part Art-Nr. für Einzelteil	Description Beschreibung
 <p>1/4 ↔ 10,5 mm</p>	114	300-114-2505 (25 cm) 300-114-3305 (33 cm) 300-114-3605 (36 cm) 300-114-4505 (45 cm)	Peritoneal scissors, single action jaws Peritoneal-Schere, einfachbeweglich
 <p>1/4 ↔ 11 mm</p>	115	300-115-2505 (25 cm) 300-115-3305 (33 cm) 300-115-3605 (36 cm) 300-115-4505 (45 cm)	Peritoneal scissors, slim, single action jaws Peritoneal-Schere, schlank, einfachbeweglich
 <p>1/4 ↔ 9 mm</p>	116	300-116-2505 (25 cm) 300-116-3305 (33 cm) 300-116-3605 (36 cm) 300-116-4505 (45 cm)	Hook scissors, single action jaws Hakenschere, einfachbeweglich
 <p>1/4 ↔ 5,5 mm</p>	118	300-118-2505 (25 cm) 300-118-3305 (33 cm) 300-118-3605 (36 cm) 300-118-4505 (45 cm)	Micro scissors, single action jaws Micro-Schere, einfachbeweglich
 <p>1/4 ↔ 12 mm</p>	119	300-119-2505 (25 cm) 300-119-3305 (33 cm) 300-119-3605 (36 cm) 300-119-4505 (45 cm)	METZENBAUM baby scissors, curved, double action jaws METZENBAUM Baby-Schere, gebogen, doppelbeweglich







SCISSORS Ø 5 mm

Scissors sets can only be ordered with
handle no. 52, 62, 84 und 184.

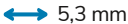
SCHEREN Ø 5 mm

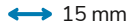
Scheren-Sets können nur für die **Griffe Nr. 52, 62, 84 und 184** bestellt werden.

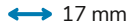
	Art No. for Set Art.-Nr. für Set	Art No. for single part Art.-Nr. für Einzelteil	Description Beschreibung
 $\frac{1}{4}$ 	120	300-120-2505 (25 cm) 300-120-3305 (33 cm) 300-120-3605 (36 cm) 300-120-4505 (45 cm)	Micro scissors, curved, single action jaws Mikro-Schere, gebogen, einfachbeweglich
 $\frac{1}{4}$ 	121	300-121-2505 (25 cm) 300-121-3305 (33 cm) 300-121-3605 (36 cm) 300-121-4505 (45 cm)	Mini scissors, curved, double action jaws Mini-Schere, gebogen, doppelbeweglich
 $\frac{1}{4}$ 	125	300-125-2505 (25 cm) 300-125-3305 (33 cm) 300-125-3605 (36 cm) 300-125-4505 (45 cm)	METZENBAUM Preparation scissors, toothed, reinforced version, curved, double action jaws METZENBAUM Präparier-Schere, gezahnt, verstärkte Ausführung, gebogen, doppelbeweglich

FORCEPS Ø 5 mm

GREIFER Ø 5 mm

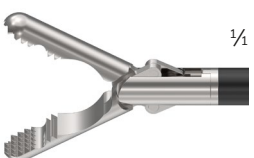
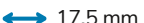
	Art No. for Set Art.-Nr. für Set	Art No. for single part Art.-Nr. für Einzelteil	Description Beschreibung
 $\frac{1}{4}$ 	210	300-210-2505 (25 cm) 300-210-3305 (33 cm) 300-210-3605 (36 cm) 300-210-4505 (45 cm)	Universal grasping forceps, double action jaws Universal-Fasszange, doppelbeweglich



FORCEPS Ø 5 mm





GREIFER Ø 5 mm

	Art No. for Set Art.-Nr. für Set	Art No. for single part Art.-Nr. für Einzelteil	Description Beschreibung
<p>1/1 21,5 mm</p>	276	300-276-2505 (25 cm) 300-276-3305 (33 cm) 300-276-3605 (36 cm) 300-276-4505 (45 cm)	Universal grasping forceps "Maxi Grip", double action jaws Universal-Fasszange „Maxi Grip“, doppelbeweglich
<p>1/1 16,5 mm</p>	211	300-211-2505 (25 cm) 300-211-3305 (33 cm) 300-211-3605 (36 cm) 300-211-4505 (45 cm)	MARYLAND grasping forceps conical, double action jaws MARYLAND Fasszange konisch, doppelbeweglich
<p>1/1 17,5 mm</p>	212	300-212-2505 (25 cm) 300-212-3305 (33 cm) 300-212-3605 (36 cm) 300-212-4505 (45 cm)	MARYLAND grasping forceps, double action jaws MARYLAND Fasszange, doppelbeweglich
<p>1/1 33,5 mm</p>	286	300-286-2505 (25 cm) 300-286-3305 (33 cm) 300-286-3605 (36 cm) 300-286-4505 (45 cm)	MARYLAND grasping forceps, DeBAKEY teeth, double action jaws MARYLAND Fasszange, DeBAKEY-Zahnung, doppelbeweglich
<p>1/1 29 mm</p>	287	300-287-2505 (25 cm) 300-287-3305 (33 cm) 300-287-3605 (36 cm) 300-287-4505 (45 cm)	Long MARYLAND grasping forceps, double action jaws Lange MARYLAND Fasszange, doppelbeweglich



FORCEPS Ø 5 mm



GREIFER Ø 5 mm

	Art No. for Set Art.-Nr. für Set	Art No. for single part Art.-Nr. für Einzelteil	Description Beschreibung
 <p>1/4</p> <p>↔ 11 mm</p>	266	300-266-2505 (25 cm) 300-266-3305 (33 cm) 300-266-3605 (36 cm) 300-266-4505 (45 cm)	KELLY Grasping forceps, double action jaws KELLY Fassungzange, doppelbeweglich
 <p>1/4</p> <p>↔ 20 mm</p>	294	300-294-2505 (25 cm) 300-294-3305 (33 cm) 300-294-3605 (36 cm) 300-294-4505 (45 cm)	Long KELLY grasping forceps, crosswise teeth, double action jaws Lange KELLY Fassungzange, kreuzverzahnt, doppelbeweglich
 <p>1/4</p> <p>↔ 16 mm</p>	213	300-213-2505 (25 cm) 300-213-3305 (33 cm) 300-213-3605 (36 cm) 300-213-4505 (45 cm)	Dissection forceps, fenestrated, double action jaws Dissektions-Fassungzange, gefenstert, doppelbeweglich
 <p>1/4</p> <p>↔ 19,5 mm</p>	214	300-214-2505 (25 cm) 300-214-3305 (33 cm) 300-214-3605 (36 cm) 300-214-4505 (45 cm)	Dissecting forceps, fenestrated, double action jaws Dissektions-Fassungzange, gefenstert, doppelbeweglich
 <p>1/4</p> <p>↔ 15 mm</p>	215	300-215-2505 (25 cm) 300-215-3305 (33 cm) 300-215-3605 (36 cm) 300-215-4505 (45 cm)	Grasping forceps "Duck Bill", fenestrated, single action jaws Fassungzange „Duck Bill“, gefenstert, einfachbeweglich



FORCEPS Ø 5 mm

GREIFER Ø 5 mm

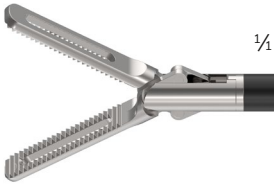
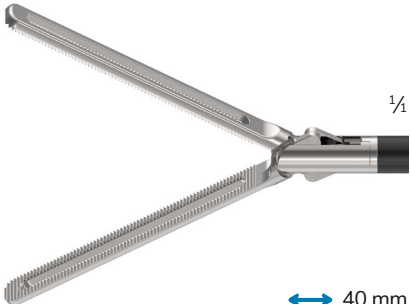
	Art No. for Set Art.-Nr. für Set	Art No. for single part Art.-Nr. für Einzelteil	Description Beschreibung
 <p>1/1</p> <p>248</p> <p>↔ 20 mm</p>		300-248-2505 (25 cm) 300-248-3305 (33 cm) 300-248-3605 (36 cm) 300-248-4505 (45 cm)	DORSEY bowel grasping forceps, fenestrated, double action jaws DORSEY Darmfasszange, gefenstert, doppelbeweglich
 <p>1/1</p> <p>249</p> <p>↔ 20 mm</p>		300-249-2505 (25 cm) 300-249-3305 (33 cm) 300-249-3605 (36 cm) 300-249-4505 (45 cm)	Retraction-/Dissecting forceps, fenestrated, single action jaws Greif-/Dissektionszange, gefenstert, einfachbeweglich
 <p>1/1</p> <p>255</p> <p>↔ 31,5 mm</p>		300-255-2505 (25 cm) 300-255-3305 (33 cm) 300-255-3605 (36 cm) 300-255-4505 (45 cm)	DORSEY bowel grasping forceps, fenestrated, double action jaws DORSEY Darmfasszange, gefenstert, doppelbeweglich
 <p>1/1</p> <p>261</p> <p>↔ 21,5 mm</p>		300-261-2505 (25 cm) 300-261-3305 (33 cm) 300-261-3605 (36 cm) 300-261-4505 (45 cm)	JOHANN Preparation- and grasping forceps, fenestrated, double action jaws JOHANN Präparier- und Fasszange, gefenstert, doppelbeweglich
 <p>1/1</p> <p>262</p> <p>↔ 40 mm</p>		300-262-2505 (25 cm) 300-262-3305 (33 cm) 300-262-3605 (36 cm) 300-262-4505 (45 cm)	Long DORSEY bowel grasping forceps, fenestrated, double action jaws Lange DORSEY Darmfasszange, gefenstert, doppelbeweglich



FORCEPS Ø 5 mm

GREIFER Ø 5 mm

	Art No. for Set Art.-Nr. für Set	Art No. for single part Art.-Nr. für Einzelteil	Description Beschreibung
<p>¼ ↔ 40 mm</p>	263	300-263-2505 (25 cm) 300-263-3305 (33 cm) 300-263-3605 (36 cm) 300-263-4505 (45 cm)	Grasping forceps, fenestrated, single action jaws Fasszange, gefenstert, einfachbeweglich
<p>¼ ↔ 41 mm</p>	267	300-267-2505 (25 cm) 300-267-3305 (33 cm) 300-267-3605 (36 cm) 300-267-4505 (45 cm)	Grasping forceps, rough tooth pitch, 90°, fenestrated, double action jaws Fasszange, grobe Zahnteilung, 90°, gefenstert, doppelbeweglich
<p>¼ ↔ 12 mm</p>	296	300-296-2505 (25 cm) 300-296-3305 (33 cm) 300-296-3605 (36 cm) 300-296-4505 (45 cm)	Strong grasping forceps, fenestrated, double action jaws Starke Fasszange, gefenstert, doppelbeweglich
<p>¼ ↔ 10 mm</p>	216	300-216-2505 (25 cm) 300-216-3305 (33 cm) 300-216-3605 (36 cm) 300-216-4505 (45 cm)	Dissecting forceps slim, fenestrated, double action jaws Dissektions-Fasszange schmal, gefenstert, doppelbeweglich
<p>¼ ↔ 12 mm</p>	217	300-217-2505 (25 cm) 300-217-3305 (33 cm) 300-217-3605 (36 cm) 300-217-4505 (45 cm)	Dissection forceps, fenestrated, double action jaws Dissektions-Fasszange, gefenstert, doppelbeweglich



FORCEPS Ø 5 mm



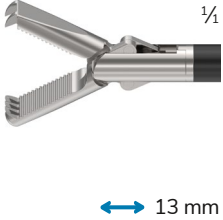
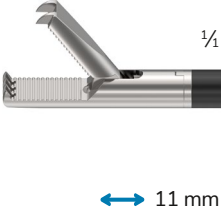
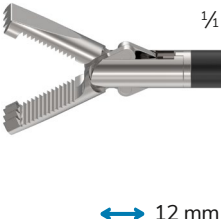
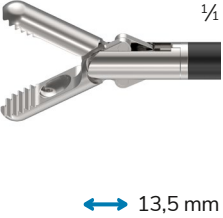
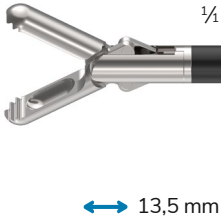

GREIFER Ø 5 mm

	Art No. for Set Art.-Nr. für Set	Art No. for single part Art.-Nr. für Einzelteil	Description Beschreibung
 <p>1/4 13 mm</p>	218	300-218-2505 (25 cm) 300-218-3305 (33 cm) 300-218-3605 (36 cm) 300-218-4505 (45 cm)	Grasping forceps with 2 + 4 teeth, double action jaws Fassungzange mit 2 + 4 Zähnen, doppelbeweglich
 <p>1/4 11 mm</p>	219	300-219-2505 (25 cm) 300-219-3305 (33 cm) 300-219-3605 (36 cm) 300-219-4505 (45 cm)	Grasping forceps with 2 + 4 teeth, single action jaws Fassungzange mit 2 + 4 Zähnen, einfachbeweglich
 <p>1/4 12 mm</p>	295	300-295-2505 (25 cm) 300-295-3305 (33 cm) 300-295-3605 (36 cm) 300-295-4505 (45 cm)	ALLIS grasping forceps, double action jaws ALLIS Fassungzange, doppelbeweglich
 <p>1/4 13,5 mm</p>	220	300-220-2505 (25 cm) 300-220-3305 (33 cm) 300-220-3605 (36 cm) 300-220-4505 (45 cm)	Grasping forceps with small reservoir, double action jaws Fassungzange mit kleinem Reservoir, doppelbeweglich
 <p>1/4 13,5 mm</p>	221	300-221-2505 (25 cm) 300-221-3305 (33 cm) 300-221-3605 (36 cm) 300-221-4505 (45 cm)	Grasping forceps with big reservoir, double action jaws Fassungzange mit großem Reservoir, doppelbeweglich

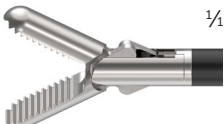

FORCEPS Ø 5 mm

GREIFER Ø 5 mm

	Art No. for Set Art.-Nr. für Set	Art No. for single part Art.-Nr. für Einzelteil	Description Beschreibung
 <p>1/1</p> <p>↔ 13,5 mm</p>	222	300-222-2505 (25 cm) 300-222-3305 (33 cm) 300-222-3605 (36 cm) 300-222-4505 (45 cm)	Grasping forceps with reservoir, sharp, double action jaws Fasszange mit Reservoir, spitz, doppelbeweglich
 <p>1/1</p> <p>↔ 9,5 mm</p>	236	300-236-2505 (25 cm) 300-236-3305 (33 cm) 300-236-3605 (36 cm) 300-236-4505 (45 cm)	Grasping forceps, double action jaws Fasszange, doppelbeweglich
 <p>1/1</p> <p>↔ 13,5 mm</p>	260	300-260-2505 (25 cm) 300-260-3305 (33 cm) 300-260-3605 (36 cm) 300-260-4505 (45 cm)	REDDICK-OLSEN grasping forceps "Duck Bill", double action jaws REDDICK-OLSEN Fasszange "Entenschnabel", doppelbeweglich
 <p>1/1</p> <p>↔ 16 mm</p>	278	300-278-2505 (25 cm) 300-278-3305 (33 cm) 300-278-3605 (36 cm) 300-278-4505 (45 cm)	Grasping forceps, round / flat, double action jaws Fasszange, rund / flach, doppelbeweglich
 <p>1/1</p> <p>↔ 23 mm</p>	288	300-288-2505 (25 cm) 300-288-3305 (33 cm) 300-288-3605 (36 cm) 300-288-4505 (45 cm)	HUNTER bowel grasping forceps, teeth fine grooved, fenestrated, double action jaws HUNTER Darmfasszange, Zahnung fein gerieft, gefenstert, doppelbeweglich



FORCEPS Ø 5 mm

GREIFER Ø 5 mm

	Art No. for Set Art.-Nr. für Set	Art No. for single part Art.-Nr. für Einzelteil	Description Beschreibung
<p>1/1 24 mm</p>	289	300-289-2505 (25 cm) 300-289-3305 (33 cm) 300-289-3605 (36 cm) 300-289-4505 (45 cm)	HUNTER bowel grasping forceps, teeth fine grooved, fenestrated, single action jaws HUNTER Darmfasszange, Zahnung fein gerieft, gefenstert, einfachbeweglich
<p>1/1 16 mm</p>	223	300-223-2505 (25 cm) 300-223-3305 (33 cm) 300-223-3605 (36 cm) 300-223-4505 (45 cm)	Grasping forceps "Dolphin" with reservoir, double action jaws Fasszange „Delphin“ mit Reservoir, doppelbeweglich
<p>1/1 17,5 mm</p>	224	300-224-2505 (25 cm) 300-224-3305 (33 cm) 300-224-3605 (36 cm) 300-224-4505 (45 cm)	Grasping forceps "Dolphin", double action jaws Fasszange „Delphin“, doppelbeweglich
<p>1/1 26 mm</p>	225	300-225-2505 (25 cm) 300-225-3305 (33 cm) 300-225-3605 (36 cm) 300-225-4505 (45 cm)	Long Grasping forceps "Dolphin" with reservoir, double action jaws Lange Fasszange „Delphin“ mit Reservoir, doppelbeweglich
<p>1/1 13,5 mm</p>	235	300-235-2505 (25 cm) 300-235-3305 (33 cm) 300-235-3605 (36 cm) 300-235-4505 (45 cm)	Short grasping forceps "Dolphin", double action jaws Kurze Fasszange „Delphin“, doppelbeweglich



FORCEPS Ø 5 mm

GREIFER Ø 5 mm

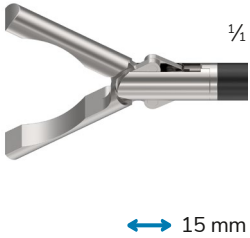
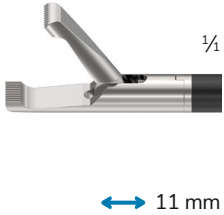
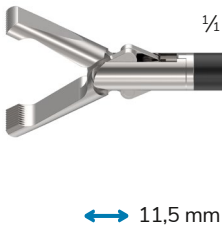
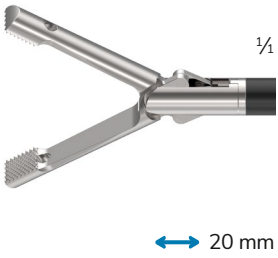
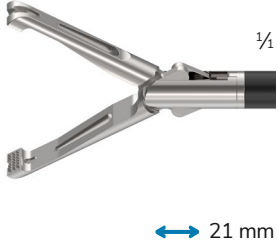
	Art No. for Set Art.-Nr. für Set	Art No. for single part Art.-Nr. für Einzelteil	Description Beschreibung
	226	300-226-2505 (25 cm) 300-226-3305 (33 cm) 300-226-3605 (36 cm) 300-226-4505 (45 cm)	Grasping forceps, smooth jaw shape, double action jaws Fassungzange, glatte Maulform, doppelbeweglich
	231	300-231-2505 (25 cm) 300-231-3305 (33 cm) 300-231-3605 (36 cm) 300-231-4505 (45 cm)	Grasping forceps distal with row of teeth, single action jaws Fassungzange distal mit Zahnreihe, einfachbeweglich
	232	300-232-2505 (25 cm) 300-232-3305 (33 cm) 300-232-3605 (36 cm) 300-232-4505 (45 cm)	Grasping forceps distal with row of teeth, double action jaws Fassungzange distal mit Zahnreihe, doppelbeweglich
	234	300-234-2505 (25 cm) 300-234-3305 (33 cm) 300-234-3605 (36 cm) 300-234-4505 (45 cm)	BABCOCK Grasping forceps, fenestrated, double action jaws BABCOCK Fassungzange, gefenstert, doppelbeweglich
	269	300-269-2505 (25 cm) 300-269-3305 (33 cm) 300-269-3605 (36 cm) 300-269-4505 (45 cm)	BABCOCK "Strong Hold" grasping forceps, fenestrated, double action jaws BABCOCK „Strong Hold“ Fassungzange, gefenstert, doppelbeweglich



FORCEPS Ø 5 mm

GREIFER Ø 5 mm

	Art No. for Set Art.-Nr. für Set	Art No. for single part Art.-Nr. für Einzelteil	Description Beschreibung
	270	300-270-2505 (25 cm) 300-270-3305 (33 cm) 300-270-3605 (36 cm) 300-270-4505 (45 cm)	BABCOCK clamp, fenestrated, double action jaws BABCOCK-Klemme, gefenstert, doppelbeweglich
	271	300-271-2505 (25 cm) 300-271-3305 (33 cm) 300-271-3605 (36 cm) 300-271-4505 (45 cm)	BABCOCK grasping forceps, "Paddle", double action jaws BABCOCK Fasszange, „Paddel“, doppelbeweglich
	273	300-273-2505 (25 cm) 300-273-3305 (33 cm) 300-273-3605 (36 cm) 300-273-4505 (45 cm)	SWANSTRÖM grasping forceps, fenestrated, double action jaws SWANSTRÖM Fasszange, gefenstert, doppelbeweglich
	290	300-290-2505 (25 cm) 300-290-3305 (33 cm) 300-290-3605 (36 cm) 300-290-4505 (45 cm)	Long ALLIS atraumatic grasping forceps, double action jaws Lange ALLIS atraumatische Fasszange, doppelbeweglich
	291	300-291-2505 (25 cm) 300-291-3305 (33 cm) 300-291-3605 (36 cm) 300-291-4505 (45 cm)	ALLIS atraumatic grasping forceps, double action jaws ALLIS atraumatische Fasszange, doppelbeweglich



FORCEPS Ø 5 mm





GREIFER Ø 5 mm

	Art No. for Set Art.-Nr. für Set	Art No. for single part Art.-Nr. für Einzelteil	Description Beschreibung
<p>¼ 238 ↔ 29 mm</p>		300-238-2505 (25 cm) 300-238-3305 (33 cm) 300-238-3605 (36 cm) 300-238-4505 (45 cm)	Grasping forceps with fine crosswise teeth, double action jaws Fasszange mit feiner Kreuzverzahnung, doppelbeweglich
<p>¼ 244 ↔ 24 mm</p>		300-244-2505 (25 cm) 300-244-3305 (33 cm) 300-244-3605 (36 cm) 300-244-4505 (45 cm)	Grasping forceps with DeBAKEY-teeth, double action jaws Fasszange mit DeBAKEY-Zahnung, doppelbeweglich
<p>¼ 227 ↔ 17 mm</p>		300-227-2505 (25 cm) 300-227-3305 (33 cm) 300-227-3605 (36 cm) 300-227-4505 (45 cm)	Micro claw forceps with teeth, double action jaws Mikro-Krallengreifzange mit Zähnen, doppelbeweglich
<p>¼ 242 ↔ 22 mm</p>		300-242-2505 (25 cm) 300-242-3305 (33 cm) 300-242-3605 (36 cm) 300-242-4505 (45 cm)	Claw grasping forceps 3+2 teeth, single action jaws Krallengreifzange 3+2 Zähne, einfachbeweglich
<p>¼ 243 ↔ 27 mm</p>		300-243-2505 (25 cm) 300-243-3305 (33 cm) 300-243-3605 (36 cm) 300-243-4505 (45 cm)	Claw grasping forceps aggressive, double action jaws Krallengreifzange aggressiv, doppelbeweglich



FORCEPS Ø 5 mm



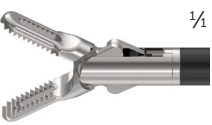

GREIFER Ø 5 mm

	Art No. for Set Art.-Nr. für Set	Art No. for single part Art.-Nr. für Einzelteil	Description Beschreibung
 <p>1/1</p> <p>↔ 14 mm</p>	228	300-228-2505 (25 cm) 300-228-3305 (33 cm) 300-228-3605 (36 cm) 300-228-4505 (45 cm)	Short grasping forceps sharp, crosswise teeth, double action jaws Kurze Fassungzange spitz, kreuzverzahnt, doppelbeweglich
 <p>1/1</p> <p>↔ 18 mm</p>	230	300-230-2505 (25 cm) 300-230-3305 (33 cm) 300-230-3605 (36 cm) 300-230-4505 (45 cm)	Long grasping forceps sharp, crosswise teeth, double action jaws Lange Fassungzange spitz, kreuzverzahnt, doppelbeweglich
 <p>1/1</p> <p>↔ 18 mm</p>	272	300-272-2505 (25 cm) 300-272-3305 (33 cm) 300-272-3605 (36 cm) 300-272-4505 (45 cm)	Grasping forceps sharp, crosswise teeth, single action jaws Fassungzange spitz, kreuzverzahnt, einfachbeweglich
 <p>1/1</p> <p>↔ 16,5 mm</p>	229	300-229-2505 (25 cm) 300-229-3305 (33 cm) 300-229-3605 (36 cm) 300-229-4505 (45 cm)	Micro grasping forceps Ø 3 mm to Ø 5 mm, straight, single action jaws Mikro-Fassungzange Ø 3 mm auf Ø 5 mm, gerade, einfachbeweglich
 <p>1/1</p> <p>↔ 12 mm</p>	298	300-298-2505 (25 cm) 300-298-3305 (33 cm) 300-298-3605 (36 cm) 300-298-4505 (45 cm)	Micro Dissecting forceps, fenestrated, double action jaws Mikro-Sezierzange, gefenestert, doppelbeweglich



FORCEPS Ø 5 mm



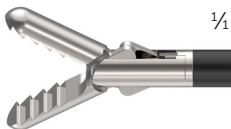

GREIFER Ø 5 mm

	Art No. for Set Art.-Nr. für Set	Art No. for single part Art.-Nr. für Einzelteil	Description Beschreibung
 <p>¼</p> <p>↔ 25 mm</p>	237	300-237-2505 (25 cm) 300-237-3305 (33 cm) 300-237-3605 (36 cm) 300-237-4505 (45 cm)	Grasping forceps with double teeth, double action jaws Fasszange mit Doppelzahnung, doppelbeweglich
 <p>¼</p> <p>↔ 13,5 mm</p>	240	300-240-2505 (25 cm) 300-240-3305 (33 cm) 300-240-3605 (36 cm) 300-240-4505 (45 cm)	Grasping forceps with mouse teeth, double action jaws Fasszange mit Mauszahn, doppelbeweglich
 <p>¼</p> <p>↔ 13,5 mm</p>	241	300-241-2505 (25 cm) 300-241-3305 (33 cm) 300-241-3605 (36 cm) 300-241-4505 (45 cm)	Grasping forceps with mouse teeth, single action jaws Fasszange mit Mauszahn, einfachbeweglich
 <p>¼</p> <p>↔ 23 mm</p>	245	300-245-2505 (25 cm) 300-245-3305 (33 cm) 300-245-3605 (36 cm) 300-245-4505 (45 cm)	Grasping forceps with rough tooth pitch, fenestrated, double action jaws Fasszange mit grober Zahnteilung, gefenstert, doppelbeweglich
 <p>¼</p> <p>↔ 13,5 mm</p>	246	300-246-2505 (25 cm) 300-246-3305 (33 cm) 300-246-3605 (36 cm) 300-246-4505 (45 cm)	Extracting forceps with a retrograde row of teeth, double action jaws Extraktionszange mit retrograder Zahnreihe, doppelbeweglich



FORCEPS Ø 5 mm

GREIFER Ø 5 mm

	Art No. for Set Art.-Nr. für Set	Art No. for single part Art.-Nr. für Einzelteil	Description Beschreibung
 <p>↔ 11 mm</p>	247	300-247-2505 (25 cm) 300-247-3305 (33 cm) 300-247-3605 (36 cm) 300-247-4505 (45 cm)	Extraction forceps, single action jaws Extraktionszange, einfachbeweglich
 <p>↔ 21,5 mm</p>	250	300-250-2505 (25 cm) 300-250-3305 (33 cm) 300-250-3605 (36 cm) 300-250-4505 (45 cm)	Atraumatic grasper with wavy teeth and reservoir, single action jaws Atraumatischer Greifer mit gewellter Zahnung und Reservoir, einfachbeweglich
 <p>↔ 26,5 mm</p>	251	300-251-2505 (25 cm) 300-251-3305 (33 cm) 300-251-3605 (36 cm) 300-251-4505 (45 cm)	Atraumatic grasper with wavy teeth and reservoir, double action jaws Atraumatischer Greifer mit gewellter Zahnung und Reservoir, doppelbeweglich
 <p>↔ 22 mm</p>	252	300-252-2505 (25 cm) 300-252-3305 (33 cm) 300-252-3605 (36 cm) 300-252-4505 (45 cm)	Retraction grasper, single action jaws Greifer zur Retraktion, einfachbeweglich
 <p>↔ 22 mm</p>	253	300-253-2505 (25 cm) 300-253-3305 (33 cm) 300-253-3605 (36 cm) 300-253-4505 (45 cm)	Retraction grasper, double action jaws Greifer zur Retraktion, doppelbeweglich



FORCEPS Ø 5 mm



GREIFER Ø 5 mm

	Art No. for Set Art.-Nr. für Set	Art No. for single part Art.-Nr. für Einzelteil	Description Beschreibung
<p>¼ 40 mm</p>	257	300-257-2505 (25 cm) 300-257-3305 (33 cm) 300-257-3605 (36 cm) 300-257-4505 (45 cm)	Long DeBAKEY forceps straight, fenestrated, double action jaws Lange DeBAKEY Fasszange gerade, gefenstert, doppelbeweglich
<p>¼ 28 mm</p>	264	300-264-2505 (25 cm) 300-264-3305 (33 cm) 300-264-3605 (36 cm) 300-264-4505 (45 cm)	Short DeBAKEY clamp, double action jaws Kurze DeBAKEY-Klemme, doppelbeweglich
<p>¼ 45 mm</p>	265	300-265-2505 (25 cm) 300-265-3305 (33 cm) 300-265-3605 (36 cm) 300-265-4505 (45 cm)	Long DeBAKEY clamp, double action jaws Lange DeBAKEY-Klemme, doppelbeweglich
<p>¼ 55 mm</p>	283	300-283-2505 (25 cm) 300-283-3305 (33 cm) 300-283-3605 (36 cm) 300-283-4505 (45 cm)	DeBAKEY forceps, straight, double action jaws DeBAKEY Fasszange, gerade, doppelbeweglich
<p>¼ 20 mm</p>	258	300-258-2505 (25 cm) 300-258-3305 (33 cm) 300-258-3605 (36 cm) 300-258-4505 (45 cm)	MIXTER grasping forceps, 90° angled, double action jaws MIXTER Fasszange, 90° gewinkelt, doppelbeweglich

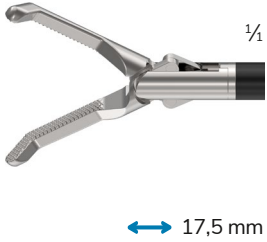
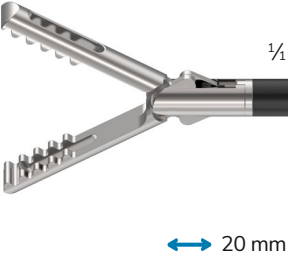
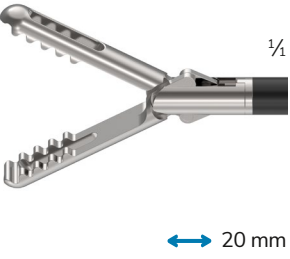
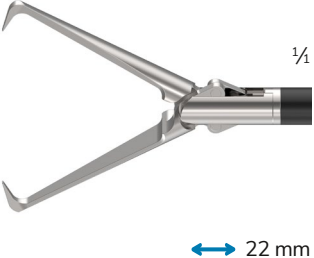

FORCEPS Ø 5 mm

GREIFER Ø 5 mm

	Art No. for Set Art.-Nr. für Set	Art No. for single part Art.-Nr. für Einzelteil	Description Beschreibung
	259	300-259-2505 (25 cm) 300-259-3305 (33 cm) 300-259-3605 (36 cm) 300-259-4505 (45 cm)	MIXTER grasping forceps, 45° angled, double action jaws MIXTER Fasszange, 45° gewinkelt, doppelbeweglich
	274	300-274-2505 (25 cm) 300-274-3305 (33 cm) 300-274-3605 (36 cm) 300-274-4505 (45 cm)	SCHERTL grasping forceps, fenestrated, double action jaws SCHERTL Fasszange, gefenstert, doppelbeweglich
	275	300-275-2505 (25 cm) 300-275-3305 (33 cm) 300-275-3605 (36 cm) 300-275-4505 (45 cm)	SCHERTL Grasping forceps, rounded, fenestrated, double action jaws SCHERTL Fasszange, abgerundet, gefenstert, doppelbeweglich
	284	300-284-2505 (25 cm) 300-284-3305 (33 cm) 300-284-3605 (36 cm) 300-284-4505 (45 cm)	Tenaculum grasping forceps, double action jaws Tenaculum Fasszange, doppelbeweglich
	285	300-285-2505 (25 cm) 300-285-3305 (33 cm) 300-285-3605 (36 cm) 300-285-4505 (45 cm)	Tenaculum grasping forceps, double action jaws Tenaculum Fasszange, doppelbeweglich



FORCEPS Ø 5 mm

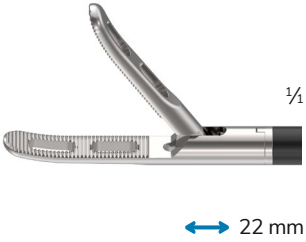
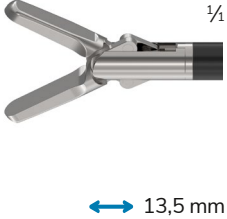
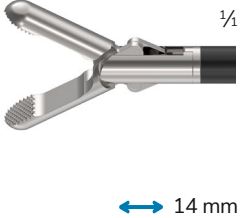
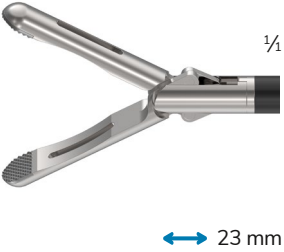
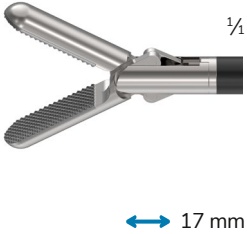

GREIFER Ø 5 mm

	Art No. for Set Art.-Nr. für Set	Art No. for single part Art.-Nr. für Einzelteil	Description Beschreibung
	292	300-292-2505 (25 cm) 300-292-3305 (33 cm) 300-292-3605 (36 cm) 300-292-4505 (45 cm)	OLMI grasping forceps, fenestrated, single action jaws OLMI Fasszange, gefenstert, einfachbeweglich
	293	300-293-2505 (25 cm) 300-293-3305 (33 cm) 300-293-3605 (36 cm) 300-293-4505 (45 cm)	REDDICK-OLSEN grasping forceps without toothing, double action jaws REDDICK-OLSEN Fasszange ohne Zahnung, doppelbeweglich
	279	300-279-2505 (25 cm) 300-279-3305 (33 cm) 300-279-3605 (36 cm) 300-279-4505 (45 cm)	Grasping forceps with fine crosswise teeth, rounded, double action jaws Fasszange mit feiner Kreuzverzahnung, abgerundet, doppelbeweglich
	355	300-355-2505 (25 cm) 300-355-3305 (33 cm) 300-355-3605 (36 cm) 300-355-4505 (45 cm)	Grasping forceps with TC insert, fenestrated, double action jaws Fasszange mit Hartmetalleinlagen, gefenstert, doppelbeweglich
	357	300-357-2505 (25 cm) 300-357-3305 (33 cm) 300-357-3605 (36 cm) 300-357-4505 (45 cm)	Strong grasping forceps with TC insert, fine, double action jaws Starke Fasszange mit Hartmetalleinlagen, fein, doppelbeweglich



FORCEPS Ø 5 mm

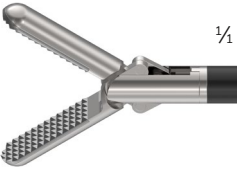

GREIFER Ø 5 mm

	Art No. for Set Art.-Nr. für Set	Art No. for single part Art.-Nr. für Einzelteil	Description Beschreibung
 <p style="text-align: right;">1/4</p> <p style="text-align: center;">297</p> <p style="text-align: center;">↔ 17 mm</p>		300-297-2505 (25 cm) 300-297-3305 (33 cm) 300-297-3605 (36 cm) 300-297-4505 (45 cm)	Strong TC grasping forceps, rough, double action jaws Starke TC-Fasszange, grob, doppelbeweglich
 <p style="text-align: right;">1/4</p> <p style="text-align: center;">299</p> <p style="text-align: center;">↔ 14 mm</p>		300-299-2505 (25 cm) 300-299-3305 (33 cm) 300-299-3605 (36 cm) 300-299-4505 (45 cm)	Dissecting forceps, flat, tapered, double action jaws Sezier-Zange, flach, verjüngt, doppelbeweglich
 <p style="text-align: right;">1/4</p> <p style="text-align: center;">351</p> <p style="text-align: center;">↔ 15 mm</p>		300-351-2505 (25 cm) 300-351-3305 (33 cm) 300-351-3605 (36 cm) 300-351-4505 (45 cm)	Grasping forceps with 1 x 2 teeth, double action jaws Fasszange mit 1 x 2 Zähne, doppelbeweglich

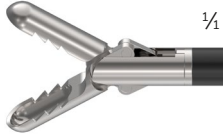
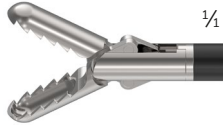
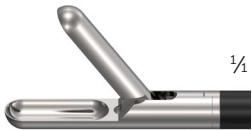

BIOPSY CUPS

BIOPSIE-LÖFFEL

	Art No. for Set Art.-Nr. für Set	Art No. for single part Art.-Nr. für Einzelteil	Description Beschreibung
 <p>1/4</p> <p>↔ 15 mm</p>	268	300-268-2505 (25 cm) 300-268-3305 (33 cm) 300-268-3605 (36 cm) 300-268-4505 (45 cm)	Tumor cup forceps, single action jaws Tumor Löffelzange, einfachbeweglich
 <p>1/4</p> <p>↔ 11 mm</p>	314	300-314-2505 (25 cm) 300-314-3305 (33 cm) 300-314-3605 (36 cm) 300-314-4505 (45 cm)	Cup forceps "Alligator", double action jaws Löffelzange „Alligator“, doppelbeweglich
 <p>1/4</p> <p>↔ 13 mm</p>	315	300-315-2505 (25 cm) 300-315-3305 (33 cm) 300-315-3605 (36 cm) 300-315-4505 (45 cm)	Cup forceps, double action jaws Löffelzange, doppelbeweglich
 <p>1/4</p> <p>↔ 14,5 mm</p>	316	300-316-2505 (25 cm) 300-316-3305 (33 cm) 300-316-3605 (36 cm) 300-316-4505 (45 cm)	Large cup, single action jaws Langer Löffel, einfachbeweglich
 <p>1/4</p> <p>↔ 14,5 mm</p>	318	300-318-2505 (25 cm) 300-318-3305 (33 cm) 300-318-3605 (36 cm) 300-318-4505 (45 cm)	Large cup with thorn, single action jaws Langer Löffel mit Dorn, einfachbeweglich
 <p>1/4</p> <p>↔ 10 mm</p>	320	300-320-2505 (25 cm) 300-320-3305 (33 cm) 300-320-3605 (36 cm) 300-320-4505 (45 cm)	Cup forceps, sharp, fenestrated, single action jaws Löffelzange, spitz, gefenstert, einfachbeweglich



BIOPSY CUPS

BIOPSIE-LÖFFEL

	Art No. for Set Art.-Nr. für Set	Art No. for single part Art.-Nr. für Einzelteil	Description Beschreibung
	310	300-310-2505 (25 cm) 300-310-3305 (33 cm) 300-310-3605 (36 cm) 300-310-4505 (45 cm)	Biopsy cup, double action jaws Biopsie-Löffel, doppelbeweglich
	312	300-312-2505 (25 cm) 300-312-3305 (33 cm) 300-312-3605 (36 cm) 300-312-4505 (45 cm)	Biopsy cup with thorn, double action jaws Biopsie-Löffel mit Dorn, doppelbeweglich

BIOPSY PUNCHES

BIOPSIE-STANZEN

	Art No. for Set Art.-Nr. für Set	Art No. for single part Art.-Nr. für Einzelteil	Description Beschreibung
	410	300-410-2505 (25 cm) 300-410-3305 (33 cm) 300-410-3605 (36 cm) 300-410-4505 (45 cm)	Biopsy punch, single action jaws Biopsie-Stanze, einfachbeweglich
	412	300-412-2505 (25 cm) 300-412-3305 (33 cm) 300-412-3605 (36 cm) 300-412-4505 (45 cm)	Biopsy punch with thorn, single action jaws Biopsie-Stanze mit Dorn, einfachbeweglich
	414	300-414-2505 (25 cm) 300-414-3305 (33 cm) 300-414-3605 (36 cm) 300-414-4505 (45 cm)	Biopsy punch with hook, single action jaws Biopsie-Stanze mit Haken, einfachbeweglich



NEEDLE HOLDERS Ø 5 mm

NADELHALTER Ø 5 mm

	Art No. for Set Art.-Nr. für Set	Art No. for single part Art.-Nr. für Einzelteil	Description Beschreibung
	350	300-350-2505 (25 cm) 300-350-3305 (33 cm) 300-350-3605 (36 cm) 300-350-4505 (45 cm)	Straight with TC insert, crosswise teeth, single action jaws Gerade mit Hartmetalleinlagen, kreuzverzahnt, einfachbeweglich
	352	300-352-2505 (25 cm) 300-352-3305 (33 cm) 300-352-3605 (36 cm) 300-352-4505 (45 cm)	Left curved with TC insert, crosswise teeth, single action jaws Links gebogen mit Hartmetalleinlagen, kreuzverzahnt, einfachbeweglich
	354	300-354-2505 (25 cm) 300-354-3305 (33 cm) 300-354-3605 (36 cm) 300-354-4505 (45 cm)	Right curved with TC insert, crosswise teeth, single action jaws Rechts gebogen mit Hartmetalleinlagen, kreuzverzahnt, einfachbeweglich
	360	300-360-2505 (25 cm) 300-360-3305 (33 cm) 300-360-3605 (36 cm) 300-360-4505 (45 cm)	Needle holder/-positioner, convex/concave shaped jaws with fixation teeth, with wolfram-carbide-coated tips, single action jaws Nadelhalter -positionierer, konvex/konvav geformte Maulform mit Fixierzähnen, Greifflächen mit Wolfram-Karbid-Beschichtung, einfachbeweglich

LAPAROSCOPY INSTRUMENTS Ø 10 mm

LAPAROSKOPIE-INSTRUMENTE Ø 10 mm



3-part system (modular)

With or without flushing connection

Available in three working lengths

Can be ordered as single parts or as a set

3-teiliges System (modular)

Mit oder ohne Spülanschluss

In drei Arbeitslängen erhältlich

Bestellbar als einzelne Teile oder als Set



TUBE SHAFTS Ø 10 mm

ROHRSCHÄFTE Ø 10 mm

Working Length Arbeitslänge	Art No. for single part Art.-Nr. für Einzelteil	Description Beschreibung
33 cm	300-100-3310	
36 cm	300-100-3610	without flushing connection ohne Spülanschluss
45 cm	300-100-4510	
33 cm	300-100-3310L	
36 cm	300-100-3610L	with flushing connection mit Spülanschluss
45 cm	300-100-4510L	



| without flushing connection
 | ohne Spülanschluss



| with flushing connection
 | mit Spülanschluss

To order sets and perform assembly/disassembly, the same principle applies as for the modular 5 mm system.

See page 19 - 22.

Um Sets zu bestellen und die Montage/Demontage durchzuführen gilt das selbe Prinzip wie beim modularen 5 mm System.

Siehe Seite 19 - 22.



FORCEPS Ø 10 mm







GREIFER Ø 10 mm

	Art No. for Set Art.-Nr. für Set	Art No. for single part Art.-Nr. für Einzelteil	Description Beschreibung
	610	300-610-3310 (33 cm) 300-610-3610 (36 cm) 300-610-4510 (45 cm)	Claw grasping and extracting forceps, 2+3 teeth, single action jaws Krallengreifzange, 2+3 Zähne, einfachbeweglich
	611	300-611-3310 (33 cm) 300-611-3610 (36 cm) 300-611-4510 (45 cm)	Claw grasping and extracting forceps, 2+3 teeth, double action jaws Krallengreifzange, 2+3 Zähne, doppelbeweglich
	612	300-612-3310 (33 cm) 300-612-3610 (36 cm) 300-612-4510 (45 cm)	MARYLAND grasping forceps, double action jaws MARYLAND Fasszange, doppelbeweglich
	614	300-614-3310 (33 cm) 300-614-3610 (36 cm) 300-614-4510 (45 cm)	Grasping forceps with DeBAKEY teeth, fenestrated, double action jaws Fasszange mit DeBAKEY Zahnung, gefenstert, doppelbeweglich
	616	300-616-3310 (33 cm) 300-616-3610 (36 cm) 300-616-4510 (45 cm)	BABCOCK grasping forceps, fenestrated, double action jaws BABCOCK grasping forceps, gefenstert, doppelbeweglich
	642	300-642-3310 (33 cm) 300-642-3610 (36 cm) 300-642-4510 (45 cm)	BABCOCK grasping forceps, with crosswise teeth, double action jaws BABCOCK Fasszange, mit Kreuzverzahnung, doppelbeweglich



FORCEPS AND CLAMPS Ø 10 mm

GREIFER UND KLEMMEN Ø 10 mm

	Art No. for Set Art.-Nr. für Set	Art No. for single part Art.-Nr. für Einzelteil	Description Beschreibung
	646	300-646-3310 (33 cm) 300-646-3610 (36 cm) 300-646-4510 (45 cm)	MIXTER grasping forceps, double action jaws MIXTER Fasszange, doppelbeweglich
		300-622-3310 (33 cm) 300-622-3610 (36 cm) 300-622-4510 (45 cm)	622 KOCHER clamp, jaw length 30 mm , double action jaws KOCHER Klemme, Maullänge 30 mm , doppelbeweglich
		300-623-3310 (33 cm) 300-623-3610 (36 cm) 300-623-4510 (45 cm)	623 KOCHER clamp, jaw length 40 mm , double action jaws KOCHER Klemme, Maullänge 40 mm , doppelbeweglich
		300-624-3310 (33 cm) 300-624-3610 (36 cm) 300-624-4510 (45 cm)	624 KOCHER clamp, jaw length 50 mm , double action jaws KOCHER Klemme, Maullänge 50 mm , doppelbeweglich
		300-631-3310 (33 cm) 300-631-3610 (36 cm) 300-631-4510 (45 cm)	631 DeBAKEY clamp, double teeth, jaw length 30 mm , double action jaws DeBAKEY Klemme, doppelte Zahnreihe, Maullänge 30 mm , doppelbeweglich
		300-632-3310 (33 cm) 300-632-3610 (36 cm) 300-632-4510 (45 cm)	632 DeBAKEY clamp, double teeth, jaw length 40 mm , double action jaws DeBAKEY Klemme, doppelte Zahnreihe, Maullänge 40 mm , doppelbeweglich
		300-633-3310 (33 cm) 300-633-3610 (36 cm) 300-633-4510 (45 cm)	633 DeBAKEY clamp, double teeth, jaw length 50 mm , double action jaws DeBAKEY Klemme, doppelte Zahnreihe, Maullänge 50 mm , doppelbeweglich



FORCEPS AND CLAMPS Ø 10 mm



GREIFER UND KLEMMEN Ø 10 mm

	Art No. for Set Art.-Nr. für Set	Art No. for single part Art.-Nr. für Einzelteil	Description Beschreibung
	656	300-656-3310 (33 cm) 300-656-3610 (36 cm) 300-656-4510 (45 cm)	<ul style="list-style-type: none"> Tenaculum forceps, double action jaws Tenaculum Fasszange, doppelbeweglich
	654	300-654-3310 (33 cm) 300-654-3610 (36 cm) 300-654-4510 (45 cm)	<ul style="list-style-type: none"> OVERHOLT clamp with fine teeth, curved, double action jaws OVERHOLT Klemme mit feiner Zahnung, gebogen, doppelbeweglich
	648	300-648-3310 (33 cm) 300-648-3610 (36 cm) 300-648-4510 (45 cm)	<ul style="list-style-type: none"> DORSEY grasping forceps, fenestrated double action jaws DORSEY Fasszange, gefenestert, doppelbeweglich
	618	300-618-3310 (33 cm) 300-618-3610 (36 cm) 300-618-4510 (45 cm)	<ul style="list-style-type: none"> BABCOCK clamp, fenestrated, double action jaws BABCOCK Klemme, gefenestert, doppelbeweglich
	620	300-620-3310 (33 cm) 300-620-3610 (36 cm) 300-620-4510 (45 cm)	<ul style="list-style-type: none"> COLLIN clamp, fenestrated, double action jaws COLLIN Klemme, gefenestert, doppelbeweglich
	650	300-650-3310 (33 cm) 300-650-3610 (36 cm) 300-650-4510 (45 cm)	<ul style="list-style-type: none"> PENNINGTON clamp, fenestrated, double action jaws PENNINGTON Klemme, gefenestert, doppelbeweglich



SCISSORS AND CUPS Ø 10 mm

SCHEREN UND LÖFFEL Ø 10 mm

	Art No. for Set Art.-Nr. für Set	Art No. for single part Art.-Nr. für Einzelteil	Description Beschreibung
	710	300-710-3310 (33 cm) 300-710-3610 (36 cm) 300-710-4510 (45 cm)	Large OP scissors, single action jaws Große OP-Schere, einfachbeweglich
	810	300-810-3310 (33 cm) 300-810-3610 (36 cm) 300-810-4510 (45 cm)	Large cup, single action jaws Großer Löffel, einfachbeweglich



INTEGRAL NEEDLE HOLDERS Ø 3 mm

INTEGRALE NADELHALTER Ø 3 mm



- | Axial ring handle with surgical ratchet and flushing connection.
- | Axialer Ringgriff mit chirurgischer Sperre und Spülanschluss.

	Description Beschreibung	Working Length Arbeitslänge	Art No. Art.-Nr.
	Straight with TC insert, crosswise teeth, single action jaws	33 cm	301-350-0050
	Gerade mit Hartmetalleinlagen, kreuzverzahnt, einfachbeweglich	21 cm	301-350-0150
	Left curved with TC insert, crosswise teeth, single action jaws	33 cm	301-352-0050
	Links gebogen mit Hartmetalleinlagen, kreuzverzahnt, einfachbeweglich	21 cm	301-352-0150
	Right curved with TC insert, crosswise teeth, single action jaws	33 cm	301-354-0050
	Rechts gebogen mit Hartmetalleinlagen, kreuzverzahnt, einfachbeweglich	21 cm	301-354-0150
	Needle holder/-positioner, convex/concave shaped jaws with fixation teeth, with wolfram-carbide-coated tips, single action jaws	33 cm	301-360-0050
	Nadelhalter -positionierer, konvex/konvav geformte Maulform mit Fixierzähnen, Greifflächen mit Wolfram-Karbid-Beschichtung, einfach- beweglich	21 cm	301-360-0150





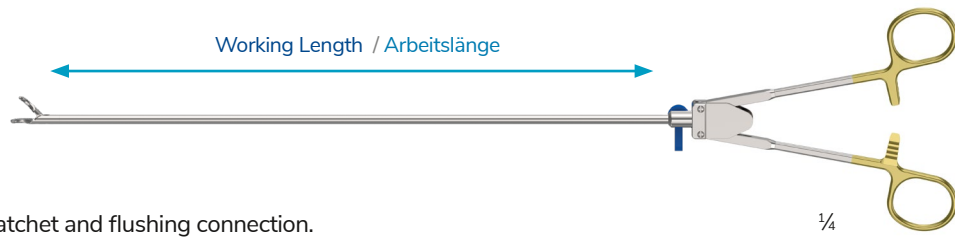

INTEGRAL NEEDLE HOLDERS Ø 5 mm

INTEGRALE NADELHALTER Ø 5 mm



| Axial ring handle with surgical ratchet and flushing connection.

| Axialer Ringgriff mit chirurgischer Sperre und Spülanschluss.

Description Beschreibung	Working Length Arbeitslänge	Art No. Art.-Nr.
 <p>Straight with TC insert, crosswise teeth, single action jaws Gerade mit Hartmetalleinlagen, kreuzverzahnt, einfachbeweglich</p>	25 cm	300-350-0150
	33 cm	300-350-0350
	36 cm	300-350-0050
	45 cm	300-350-0250
 <p>Left curved with TC insert, crosswise teeth, single action jaws Links gebogen mit Hartmetalleinlagen, kreuzverzahnt, einfachbeweglich</p>	25 cm	300-352-0150
	33 cm	300-352-0350
	36 cm	300-352-0050
 <p>Right curved with TC insert, crosswise teeth, single action jaws Rechts gebogen mit Hartmetalleinlagen, kreuzverzahnt, einfachbeweglich</p>	45 cm	300-352-0250
	25 cm	300-354-0150
	33 cm	300-354-0350
 <p>Rechts gebogen mit Hartmetalleinlagen, kreuzverzahnt, einfachbeweglich</p>	36 cm	300-354-0050
	45 cm	300-354-0250
	 <p>Needle holder/-positioner, convex/concave shaped jaws with fixation teeth, with wolfram-carbide-coated tips, single action jaws Nadelhalter -positionierer, konvex/konvav geformte Maulform mit Fixierzähnen, Greifflächen mit Wolfram-Karbid-Beschichtung, einfach- beweglich</p>	25 cm
33 cm		300-360-0350
36 cm		300-360-0050
45 cm		300-360-0250





INTEGRAL NEEDLE HOLDERS Ø 3 mm

INTEGRALE NADELHALTER Ø 3 mm



- | Axial handle with ratchet, retaining spring and flushing connection.
- | Axialgriff mit Sperre, Rückstellfeder und Spülanschluss.

¼

	Description Beschreibung	Working Length Arbeitslänge	Art No. Art.-Nr.
	Straight with TC insert, crosswise teeth, single action jaws	33 cm	301-350-0060
	Gerade mit Hartmetalleinlagen, kreuzverzahnt, einfachbeweglich	21 cm	301-350-0160
	Left curved with TC insert, crosswise teeth, single action jaws	33 cm	301-352-0060
	Links gebogen mit Hartmetalleinlagen, kreuzverzahnt, einfachbeweglich	21 cm	301-352-0160
	Right curved with TC insert, crosswise teeth, single action jaws	33 cm	301-354-0060
	Rechts gebogen mit Hartmetalleinlagen, kreuzverzahnt, einfachbeweglich	21 cm	301-354-0160
	Needle holder/-positioner, convex/concave shaped jaws with fixation teeth, with wolfram-carbide-coated tips, single action jaws	33 cm	301-360-0060
	Nadelhalter -positionierer, konvex/konvav geformte Maulform mit Fixierzähnen, Greifflächen mit Wolfram-Karbid-Beschichtung, einfach- beweglich	21 cm	301-360-0160



INTEGRAL NEEDLE HOLDERS Ø 5 mm





INTEGRALE NADELHALTER Ø 5 mm



| Axial handle with ratchet, retaining spring and flushing connection.

| Axialgriff mit Sperre, Rückstellfeder und Spülanschluss.

¼

Description Beschreibung	Working Length Arbeitslänge	Art No. Art.-Nr.
 <p>Straight with TC insert, crosswise teeth, single action jaws Gerade mit Hartmetalleinlagen, kreuzverzahnt, einfachbeweglich</p>	25 cm	300-350-0160
	33 cm	300-350-0360
	36 cm	300-350-0060
	45 cm	300-350-0260
 <p>Left curved with TC insert, crosswise teeth, single action jaws Links gebogen mit Hartmetalleinlagen, kreuzverzahnt, einfachbeweglich</p>	25 cm	300-352-0160
	33 cm	300-352-0360
	36 cm	300-352-0060
 <p>Right curved with TC insert, crosswise teeth, single action jaws Rechts gebogen mit Hartmetalleinlagen, kreuzverzahnt, einfachbeweglich</p>	45 cm	300-352-0260
	25 cm	300-354-0160
	33 cm	300-354-0360
 <p>Needle holder/-positionier, convex/concave shaped jaws with fixation teeth, with wolfram-carbide-coated tips, single action jaws Nadelhalter -positionierer, konvex/konvav geformte Maulform mit Fixierzähnen, Greifflächen mit Wolfram-Karbid-Beschichtung, einfach- beweglich</p>	36 cm	300-354-0060
	45 cm	300-354-0260
	25 cm	300-360-0160
	33 cm	300-360-0360
	36 cm	300-360-0060
	45 cm	300-360-0260







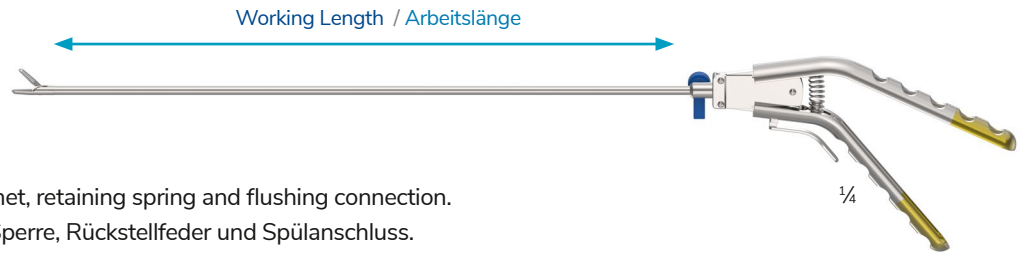

INTEGRAL NEEDLE HOLDERS Ø 3 mm

INTEGRALE NADELHALTER Ø 3 mm



| Angled axial handle with ratchet, retaining spring and flushing connection.

| Abgewinkelter Axialgriff mit Sperre, Rückstellfeder und Spülanschluss.

	Description Beschreibung	Working Length Arbeitslänge	Art No. Art.-Nr.
	Straight with TC insert, crosswise teeth, single action jaws	33 cm	301-350-0070
	Gerade mit Hartmetalleinlagen, kreuzverzahnt, einfachbeweglich	21 cm	301-350-0170
	Left curved with TC insert, crosswise teeth, single action jaws	33 cm	301-352-0070
	Links gebogen mit Hartmetalleinlagen, kreuzverzahnt, einfachbeweglich	21 cm	301-352-0170
	Right curved with TC insert, crosswise teeth, single action jaws	33 cm	301-354-0070
	Rechts gebogen mit Hartmetalleinlagen, kreuzverzahnt, einfachbeweglich	21 cm	301-354-0170
	Needle holder/-positioner, convex/concave shaped jaws with fixation teeth, with wolfram-carbide-coated tips, single action jaws	33 cm	301-360-0070
	Nadelhalter -positionierer, konvex/konvav geformte Maulform mit Fixierzähnen, Greifflächen mit Wolfram-Karbid-Beschichtung, einfach- beweglich	21 cm	301-360-0170



INTEGRAL NEEDLE HOLDERS Ø 5 mm

INTEGRALE NADELHALTER Ø 5 mm

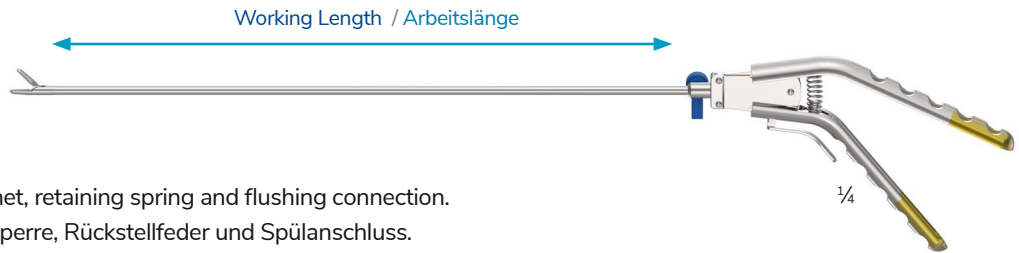

| Angled axial handle with ratchet, retaining spring and flushing connection.

| Abgewinkelter Axialgriff mit Sperre, Rückstellfeder und Spülanschluss.

Description Beschreibung	Working Length Arbeitslänge	Art No. Art.-Nr.	
	25 cm	300-350-0170	
Straight with TC insert, crosswise teeth, single action jaws	33 cm	300-350-0370	
	36 cm	300-350-0070	
Gerade mit Hartmetalleinlagen, kreuzverzahnt, einfachbeweglich	45 cm	300-350-0270	
	25 cm	300-352-0170	
Left curved with TC insert, crosswise teeth, single action jaws	33 cm	300-352-0370	
	36 cm	300-352-0070	
Links gebogen mit Hartmetalleinlagen, kreuzverzahnt, einfachbeweglich	45 cm	300-352-0270	
	25 cm	300-354-0170	
Right curved with TC insert, crosswise teeth, single action jaws	33 cm	300-354-0370	
	36 cm	300-354-0070	
Rechts gebogen mit Hartmetalleinlagen, kreuzverzahnt, einfachbeweglich	45 cm	300-354-0270	
	25 cm	300-360-0170	
Needle holder/-positionier, convex/concave shaped jaws with fixation teeth, with wolfram-carbide-coated tips, single action jaws	33 cm	300-360-0370	
		36 cm	300-360-0070
Nadelhalter -positionierer, konvex/konvav geformte Maulform mit Fixierzähnen, Greifflächen mit Wolfram-Karbid-Beschichtung, einfach- beweglich	45 cm	300-360-0270	



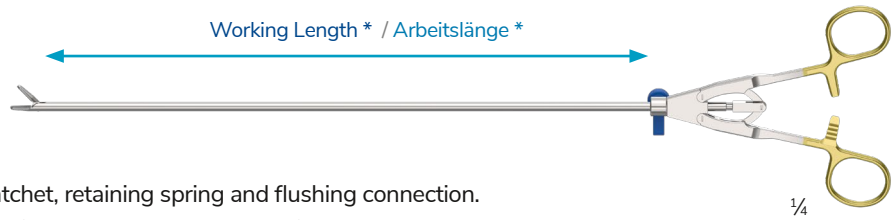

INTEGRAL NEEDLE HOLDERS Ø 5 mm

INTEGRALE NADELHALTER Ø 5 mm



| Axial ring handle with surgical ratchet, retaining spring and flushing connection.
 | Axialer Ringgriff mit chirurgischer Sperre, Rückstellfeder und Spülanschluss.

| *Other working lengths are available on request. | *Abweichende Arbeitslängen sind auf Anfrage möglich.

	Description Beschreibung	Working Length Arbeitslänge	Art No. Art.-Nr.
	Straight with TC insert, crosswise teeth, single action jaws	35 cm	300-954-0350
	Gerade mit Hartmetalleinlagen, kreuzverzahnt, einfachbeweglich	45 cm	300-954-0450
	Left curved with TC insert, crosswise teeth, single action jaws	35 cm	300-955-0350
	Links gebogen mit Hartmetalleinlagen, kreuzverzahnt, einfachbeweglich	45 cm	300-955-0450
	Right curved with TC insert, crosswise teeth, single action jaws	35 cm	300-956-0350
	Rechts gebogen mit Hartmetalleinlagen, kreuzverzahnt, einfachbeweglich	45 cm	300-956-0450





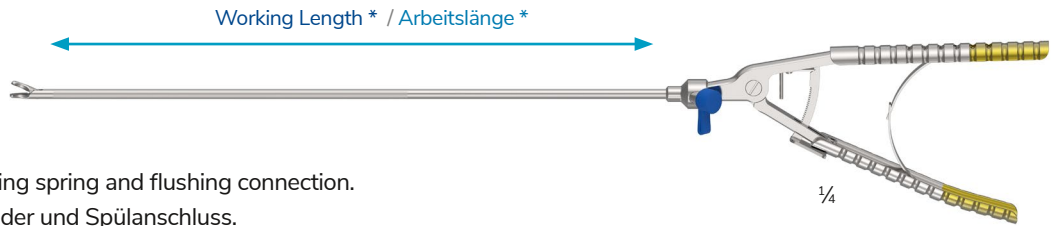

INTEGRAL NEEDLE HOLDERS Ø 5 mm

INTEGRALE NADELHALTER Ø 5 mm



| Axial handle with ratchet, retaining spring and flushing connection.
 | Axialgriff mit Sperre, Rückstellfeder und Spülanschluss.

| *Other working lengths are available on request. | *Abweichende Arbeitslängen sind auf Anfrage möglich.

	Description Beschreibung	Working Length Arbeitslänge	Art No. Art.-Nr.
	Straight with TC insert, crosswise teeth, single action jaws	33 cm	300-914-0330
	Gerade mit Hartmetalleinlagen, kreuzverzahnt, einfachbeweglich	45 cm	300-914-0450
	Left curved with TC insert, crosswise teeth, single action jaws	33 cm	300-915-0330
	Links gebogen mit Hartmetalleinlagen, kreuzverzahnt, einfachbeweglich	45 cm	300-915-0450
	Right curved with TC insert, crosswise teeth, single action jaws	33 cm	300-916-0330
	Rechts gebogen mit Hartmetalleinlagen, kreuzverzahnt, einfachbeweglich	45 cm	300-916-0450
	Needle holder/-positioner, convex/concave shaped jaws with fixation teeth, with wolfram-carbide-coated tips, single action jaws	33 cm	300-918-0330
	Nadelhalter -positionierer, konvex/konvav geformte Maulform mit Fixierzähnen, Greifflächen mit Wolfram-Karbid-Beschichtung, einfach- beweglich	45 cm	300-918-0450





INTEGRAL NEEDLE HOLDERS Ø 5 mm

INTEGRALE NADELHALTER Ø 5 mm



| Axial handle with ratchet, retaining spring and flushing connection.
 | Axialgriff mit Sperre, Rückstellfeder und Spülanschluss.

| *Other working lengths are available on request. | *Abweichende Arbeitslängen sind auf Anfrage möglich.

	Description Beschreibung	Working Length Arbeitslänge	Art No. Art.-Nr.
	Straight with TC insert, crosswise teeth, single action jaws	33 cm	300-924-0330
	Gerade mit Hartmetalleinlagen, kreuzverzahnt, einfachbeweglich	45 cm	300-924-0450
	Left curved with TC insert, crosswise teeth, single action jaws	33 cm	300-925-0330
	Links gebogen mit Hartmetalleinlagen, kreuzverzahnt, einfachbeweglich	45 cm	300-925-0450
	Right curved with TC insert, crosswise teeth, single action jaws	33 cm	300-926-0330
	Rechts gebogen mit Hartmetalleinlagen, kreuzverzahnt, einfachbeweglich	45 cm	300-926-0450



INTEGRAL SLIDE LOCK GRASPERS Ø 5 mm

INTEGRALE SLIDE LOCK GREIFZANGEN Ø 5 mm

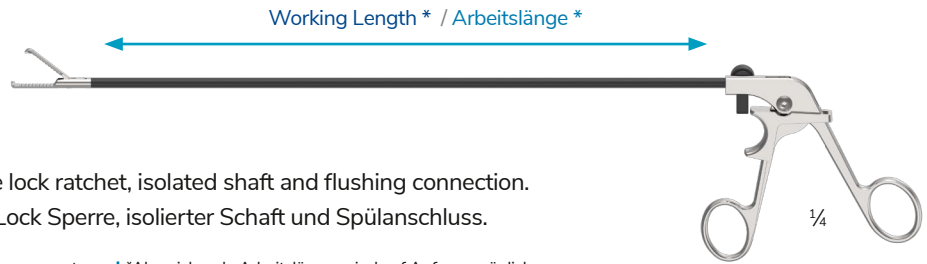



| Axial ring handle with slide lock ratchet, isolated shaft and flushing connection.
 | Axialer Ringgriff mit Slide Lock Sperre, isolierter Schaft und Spülanschluss.

| *Other working lengths are available on request. | *Abweichende Arbeitslängen sind auf Anfrage möglich.



Atraumatic Grasper

Atraumatische Greifzangen

	Description Beschreibung	Working Length Arbeitslänge	Art No. Art.-Nr.
	Atraumatic grasper, wavy teeth with Reservoir, single action jaws	36 cm	PT250-36-01
	Atraumatische Greifzange, gewellte Zahnung mit Reservoir, einfachbeweglich	45 cm	PT250-45-01
	Atraumatic grasper, wavy teeth with Reservoir, double action jaws	36 cm	PT251-36-01
	Atraumatische Greifzange, gewellte Zahnung mit Reservoir, doppelbeweglich	45 cm	PT251-45-01

Retraction Grasper

Retraktions-Greifzangen

	Description Beschreibung	Working Length Arbeitslänge	Art No. Art.-Nr.
	Retraction grasper, wavy teeth, single action jaws	36 cm	PT252-36-01
	Retraktions-Greifzange, gewellte Zahnung, einfachbeweglich	45 cm	PT252-45-01
	Retraction grasper, wavy teeth, double action jaws	36 cm	PT253-36-01
	Retraktions-Greifzange, gewellte Zahnung, doppelbeweglich	45 cm	PT253-45-01



INTEGRAL SLIDE LOCK GRASPERS Ø 5 mm

INTEGRALE SLIDE LOCK GREIFZANGEN Ø 5 mm

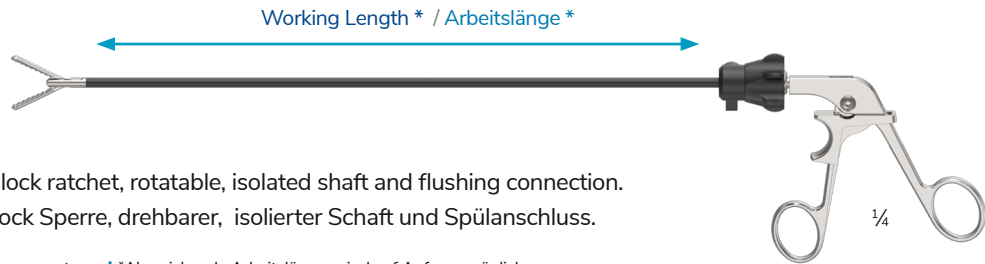

| Axial ring handle with slide lock ratchet, rotatable, isolated shaft and flushing connection.
 | Axialer Ringgriff mit Slide Lock Sperre, drehbarer, isolierter Schaft und Spülanschluss.

| *Other working lengths are available on request. | *Abweichende Arbeitslängen sind auf Anfrage möglich.

Atraumatic Grasper

Atraumatische Greifzangen

	Description Beschreibung	Working Length Arbeitslänge	Art No. Art.-Nr.
	Atraumatic grasper, wavy teeth with Reservoir, single action jaws	36 cm	PT250-36-02
	Atraumatische Greifzange, gewellte Zahnung mit Reservoir, einfachbeweglich	45 cm	PT250-45-02
	Atraumatic grasper, wavy teeth with Reservoir, double action jaws	36 cm	PT251-36-02
	Atraumatische Greifzange, gewellte Zahnung mit Reservoir, doppelbeweglich	45 cm	PT251-45-02

Retraction Grasper

Retraktions-Greifzangen

	Description Beschreibung	Working Length Arbeitslänge	Art No. Art.-Nr.
	Retraction grasper, wavy teeth, single action jaws	36 cm	PT252-36-02
	Retraktions-Greifzange, gewellte Zahnung, einfachbeweglich	45 cm	PT252-45-02
	Retraction grasper, wavy teeth, double action jaws	36 cm	PT253-36-02
	Retraktions-Greifzange, gewellte Zahnung, doppelbeweglich	45 cm	PT253-45-02



**Your focus is on people.
Our focus is on the details.**

ERGONOMICS, VERSATILITY,
ECONOMY AND QUALITY.

ERGONOMIE, VIELSEITIGKEIT, WIRT-
SCHAFTLICHKEIT UND QUALITÄT.







shaft Ø 10 mm

shaft Ø 5 mm



RETRACTORS

RETRAKTOREN

Working Length Arbeitslänge	Art No. shaft Ø 5 mm Art.-Nr. Schaft-Ø 5 mm	Art No. shaft Ø 10 mm Art.-Nr. Schaft-Ø 10 mm	Quantity fingers Anzahl Finger	Description Beschreibung	
33 cm	300-901-3505	300-901-3510	5	Fan Retractor, spread 42 mm Fächer Retraktor, Spreizung 42 mm	
36 cm	300-901-3605	300-901-3610			
45 cm	300-901-4505	300-901-4510			
33 cm	300-902-3505	300-902-3510	5	Fan Retractor, spread 55 mm, swivelling 45° Fächer Retraktor Spreizung 55 mm, aufschwenkbar 45°	
36 cm	300-902-3605	300-902-3610			
45 cm	300-902-4505	300-902-4510			
33 cm	300-903-3505	300-903-3510	3	Fan Retractor, spread 42 mm Fächer Retraktor Spreizung 42 mm	
36 cm	300-903-3605	300-903-3610			
45 cm	300-903-4505	300-903-4510			
33 cm	300-904-3505	300-904-3510	1	Esophageal Retractor, fenestrated with 2,5 x 1,5 mm Speiseröhre-Retraktor, gefenstert mit 2,5 x 1,5 mm	
36 cm	300-904-3605	300-904-3610			
42 cm	300-904-4205	300-904-4210			
45 cm	300-904-4505	300-904-4510			



CHOLANGIOGRAPHY Ø 5 mm

Cholangiography fixation clamp with channel
 for 6 Charrier-catheters.

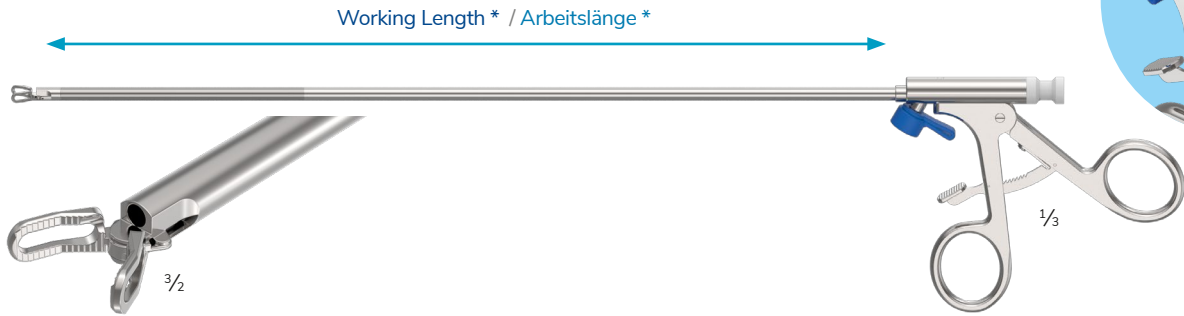

| *Other working lengths are available on request. | *Abweichende Arbeitslängen sind auf Anfrage möglich.

Art No. Art.-Nr.	Working Length Arbeitslänge
300-22927-05	33 cm

| with flushing connection
 | mit Spülanschluss

CHOLANGIOGRAPHIE Ø 5 mm

Cholangiographie-Fixierzange mit Kanal
 für 6 Charrier-Katheter

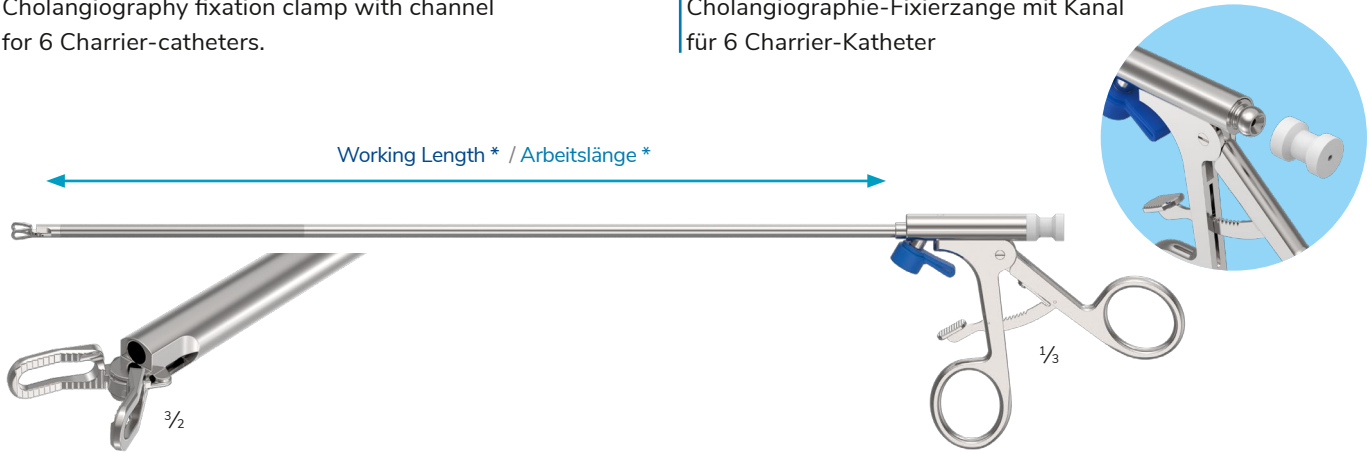

| *Other working lengths are available on request. | *Abweichende Arbeitslängen sind auf Anfrage möglich.

Art No. Art.-Nr.	Working Length Arbeitslänge
300-22927-05	33 cm

| with flushing connection
 | mit Spülanschluss

CHOLANGIOGRAPHY Ø 5 mm

Cholangiography fixation clamp with channel
 for 6 Charrier-catheters.

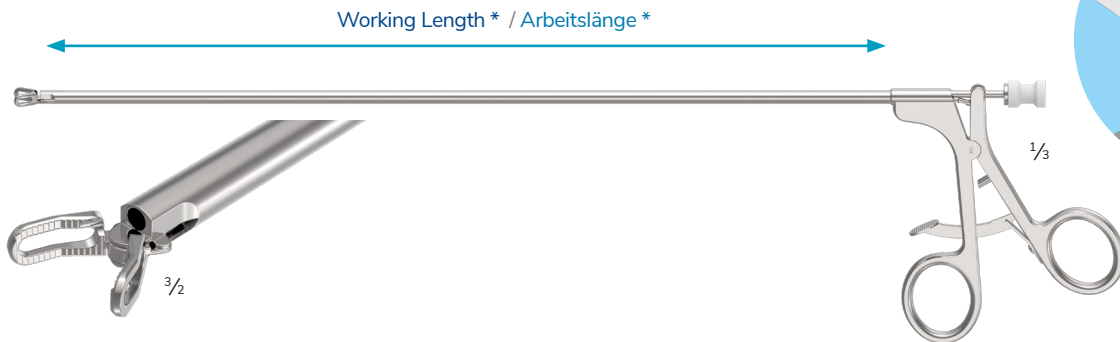

| *Other working lengths are available on request. | *Abweichende Arbeitslängen sind auf Anfrage möglich.

Art No. Art.-Nr.	Working Length Arbeitslänge
300-22923-05	33 cm

| with flushing connection
 | mit Spülanschluss

CHOLANGIOGRAPHIE Ø 5 mm

Cholangiographie-Fixierzange mit Kanal
 für 6 Charrier-Katheter

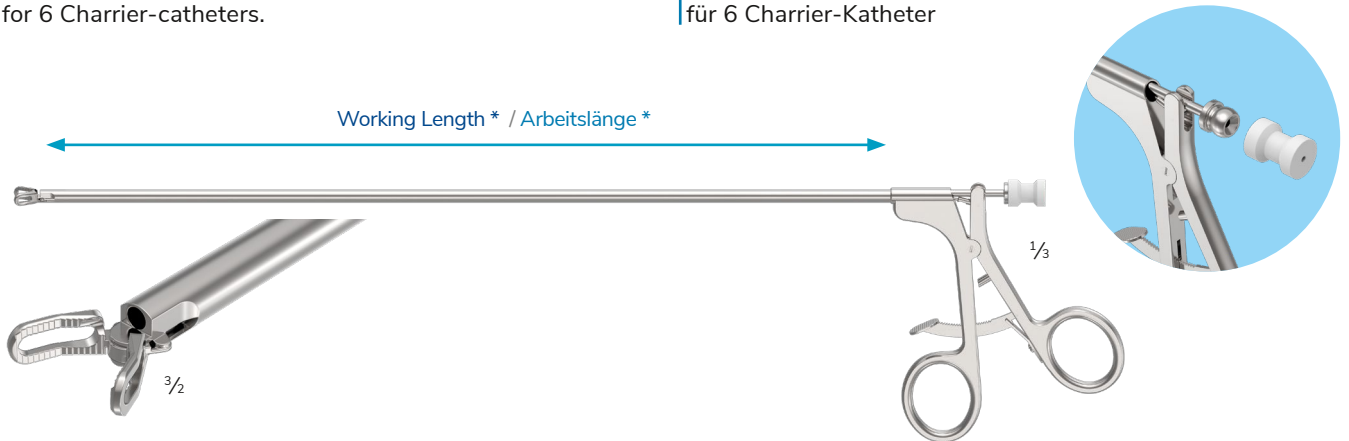

| *Other working lengths are available on request. | *Abweichende Arbeitslängen sind auf Anfrage möglich.

Art No. Art.-Nr.	Working Length Arbeitslänge
300-22923-05	33 cm

| with flushing connection
 | mit Spülanschluss

510(k)



BEMA GmbH + Co. KG | Rudolf-Diesel-Straße 12 | D-78576 Emmingen

+49 (0) 74 65 / 92 99-0

www.bemamedical.com

+49 (0) 74 65 / 92 99-29

mail@bemamedical.com

Unser Unternehmen ist zertifiziert nach EN ISO 13485. Außerdem besteht eine Registrierung bei der FDA und 510(k) für Klasse IIb Produkte.

BEMA is certified pursuant to EN ISO 13485 and registered with the FDA and 510(k) for Class IIb products.