

MIS-INSTRUMENTS LAP-INSTRUMENTE

modular and integral
laparoscopic instruments
modulare und integrale
Laparoskopie-Instrumente



BEMA MEDICAL the company

Solutions. Not compromises.

The smallest details make all the difference in life. Users of laparoscopy are very aware of this. As a purchaser and decision-maker, you know this. This is why details are our main focus at BEMA. Details that make a huge difference in terms of ergonomics, versatility, economy and quality.

Today we are both nationally and internationally recognized partners for minimally invasive instruments complying with EN ISO 13485 norms. Developed through practice for practices! Always highly individualized and with modular systems for even more flexibility in applications and processes.

Our products are based on what your specific needs are. We have developed our own patented modular tube shaft system mainly for use in laparoscopy. The result: instruments that are not the benchmarks for competitors – but much more: for people! Welcome to BEMA!

Your focus is on people. Our focus is on the details.

Let us give you some insight into this fascinating field!

And in case you'd like to know more: just ask us!

BEMA – if it's quality that you expect!

Lösungen. Keine Kompromisse.

Feinste Details entscheiden im Leben. Und: über das Leben. Das wissen Anwender in der Laparoskopie. Das wissen Sie als Einkäufer und Entscheider. Deshalb konzentrieren wir bei BEMA uns auf Details. Auf Details, die den Unterschied machen. Hinsichtlich Ergonomie, Vielseitigkeit, Wirtschaftlichkeit – und Qualität.

Heute sind wir national und international geschätzter Partner für minimalinvasive Instrumente nach EN ISO 13485. Aus der Praxis. Für die Praxis! Immer hoch individuell. Mit Baukastensystemen für noch mehr Flexibilität in Anwendungen und Abläufen.

Unsere Basis: Ihre besonderen Ansprüche. Unser selbst entwickeltes und urheberrechtlich geschütztes modulares Rohrerschaftsystem für den Hauptbereich Laparoskopie. Das Ergebnis: Instrumente, die nicht die Mitbewerber zum Maßstab haben – sondern weit mehr: den Menschen! Herzlich willkommen bei BEMA!

Sie haben den Menschen im Blick. Wir die Details.

Wir geben Ihnen Einblick – auf den folgenden Seiten!

Und wenn Sie noch mehr wissen wollen: Fragen Sie uns!

BEMA – wenn es Qualität ist, was Sie erwarten!



Thomas Becker -
Business manager, founder and owner.
Your partner for all inquiries!

BEMA GmbH + Co. KG · Rudolf-Diesel-Str. 12 · D-78576 Emmingen/Germany
phone: ++49 (0)7465-9299-0 · fax: ++49 (0)7465-9299-29
website: www.bemamedical.com · e-mail: mail@bemamedical.com

MINIMALLY INVASIVE SURGERY - INDEX

DISCRIPTION **page**

modular laparoscopy instruments:

| | |
|--|-----------|
| <i>modular handles for 2- and 3-part system</i> | 4 |
| <i>modular 2-part Ø 3 mm system - how to order a complete instrument (set)</i> | 9 |
| <i>modular 2-part Ø 3 mm system - assembly and disassembly</i> | 10 |
| <i>modular 2-part Ø 3 mm system - working parts.</i> | 12 |
| <i>modular 3-part Ø 5 and 10 mm systems - how to order a complete instrument (set)</i> | 19 |
| <i>modular 3-part Ø 5 and 10 mm systems - assembly and disassembly</i> | 20 |
| <i>modular 3-part Ø 5 mm system - tube shafts</i> | 23 |
| <i>modular 3-part Ø 5 mm system - inserts</i> | 24 |
| <i>modular 3-part Ø 10 mm system - tube shafts</i> | 49 |
| <i>modular 3-part Ø 10 mm system - inserts.</i> | 50 |

integral laparoscopy instruments:

| | |
|--|-----------|
| <i>integral Ø 3 and 5 mm instruments - needle holders</i> | 54 |
| <i>integral Ø 5 mm instruments - slide lock graspers</i> | 64 |
| <i>integral Ø 5 and 10 mm instruments - fan retractors</i> | 66 |
| <i>integral Ø 5 mm instruments - cholangiography fixation clamps</i> | 68 |



ANGLED HIGHLY RIGID PLASTIC HANDLE

Ergonomic ring handles with rotation module,
 available with or without HF connection

| Art No. for Set Art-Nr. für Set | Art. No. for single part Art.-Nr. für Einzelteil | Description Beschreibung |
|------------------------------------|---|--|
| 80 | 300-100-0080 | with HF-connection mit HF-Anschluss |
| 180 | 300-100-0180 | without HF-connection ohne HF-Anschluss |

| stepless ratchet, ratchet deactivable, release key
 | stufenlose Sperre, Sperre deaktivierbar, Entriegelungstaste

ABGEWINKELTE KUNSTSTOFFGRIFFE

Ergonomische Ringgriffe mit Rotationsmodul,
 erhältlich mit oder ohne HF-Anschluss

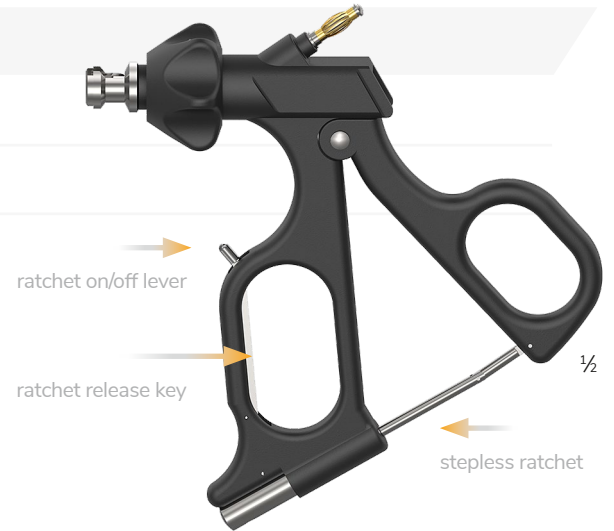

| Art No. for Set Art-Nr. für Set | Art. No. for single part Art.-Nr. für Einzelteil | Description Beschreibung |
|------------------------------------|---|--|
| 81 | 300-100-0081 | with HF-connection mit HF-Anschluss |
| 181 | 300-100-0181 | without HF-connection ohne HF-Anschluss |

| stepless ratchet, release key
 | stufenlose Sperre, Entriegelungstaste



| Art No. for Set Art-Nr. für Set | Art. No. for single part Art.-Nr. für Einzelteil | Description Beschreibung |
|------------------------------------|---|--|
| 82 | 300-100-0082 | with HF-connection mit HF-Anschluss |
| 182 | 300-100-0182 | without HF-connection ohne HF-Anschluss |

| fold-out ratchet, ratchet deactivable
 | ausklappbare Sperre, Sperre deaktivierbar





ANGLED HIGHLY RIGID PLASTIC HANDLE

Ergonomic ring handles with rotation module,
 available with or without HF connection

ABGEWINKELTE KUNSTSTOFFGRIFFE

Ergonomische Ringgriffe mit Rotationsmodul,
 erhältlich mit oder ohne HF-Anschluss

| Art No. for Set Art-Nr. für Set | Art. No. for single part Art.-Nr. für Einzelteil | Description Beschreibung |
|------------------------------------|---|--|
| 84 | 300-100-0084 | with HF-connection mit HF-Anschluss |
| 184 | 300-100-0184 | without HF-connection ohne HF-Anschluss |



| Art No. for Set Art-Nr. für Set | Art. No. for single part Art.-Nr. für Einzelteil | Description Beschreibung |
|------------------------------------|---|--|
| 85 | 300-100-0085 | with HF-connection mit HF-Anschluss |
| 185 | 300-100-0185 | without HF-connection ohne HF-Anschluss |



ratchet deactivable, release key
 Sperre deaktivierbar, Entriegelungstaste

ratchet release key

deactivate ratchet button



AXIAL HANDLES

AXIALGRIFFE

| Art No. for Set Art-Nr. für Set | Art. No. for single part Art.-Nr. für Einzelteil |
|------------------------------------|---|
| 50 | 300-100-0050 |

| Axial handle with rings and ratchet
 | Axialgriff mit Ringen und Sperre



| Art No. for Set Art-Nr. für Set | Art. No. for single part Art.-Nr. für Einzelteil |
|------------------------------------|---|
| 52 | 300-100-0052 |

| Axial handle with rings
 | Axialgriff mit Ringen



| Art No. for Set Art-Nr. für Set | Art. No. for single part Art.-Nr. für Einzelteil |
|------------------------------------|---|
| 60 | 300-100-0060 |

| Axial handle with spreading spring and ratchet
 | Axialgriff mit Spreizfeder und Sperre

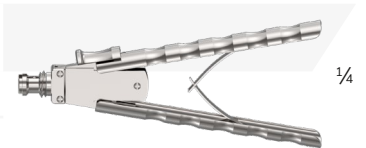

| Art No. for Set Art-Nr. für Set | Art. No. for single part Art.-Nr. für Einzelteil |
|------------------------------------|---|
| 62 | 300-100-0062 |

| Axial handle with spreading spring
 | Axialgriff mit Spreizfeder

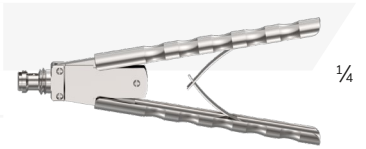

| Art No. for Set Art-Nr. für Set | Art. No. for single part Art.-Nr. für Einzelteil |
|------------------------------------|---|
| 70 | 300-100-0070 |

| Axial handle angled with spreading spring and ratchet
 | Axialgriff gewinkelt mit Spreizfeder und Sperre

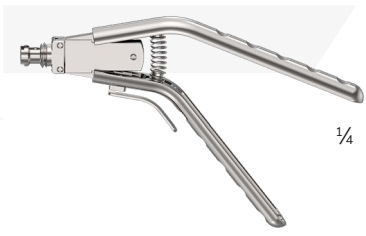

| Art No. for Set Art-Nr. für Set | Art. No. for single part Art.-Nr. für Einzelteil |
|------------------------------------|---|
| 72 | 300-100-0072 |

| Axial handle angled with spreading spring
 | Axialgriff gewinkelt mit Spreizfeder



Full compatibility in the BEMA system!
All handles fit all tube shafts.

Volle Kompatibilität im BEMA-System!
Alle Griffe passen zu allen Rohrschäften.

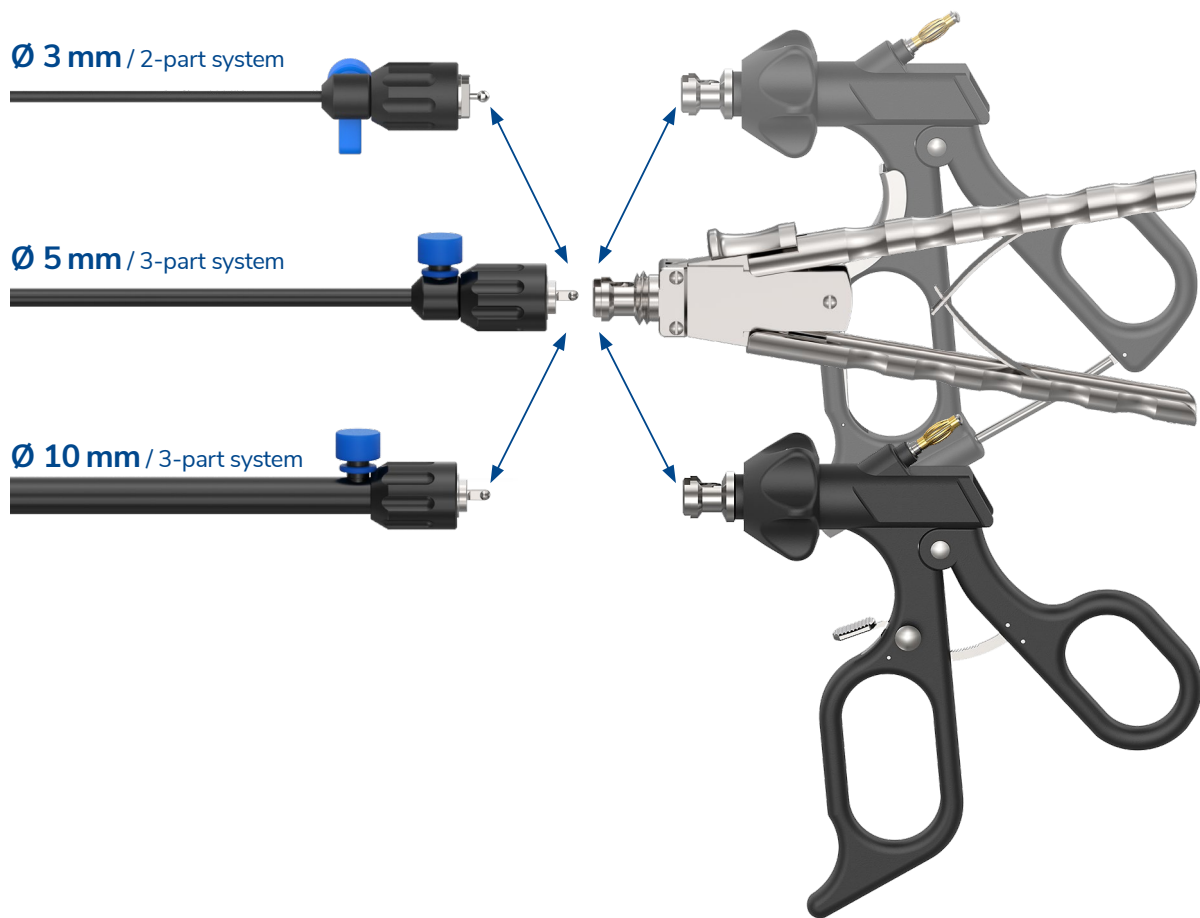

LAPAROSCOPY INSTRUMENTS Ø 3 mm

LAPAROSKOPIE-INSTRUMENTE Ø 3 mm



2-part system (modular)

With or without flushing connection

Available in three working lengths

Can be ordered as single parts or as a set

2-teiliges System (modular)

Mit oder ohne Spülanschluss

In drei Arbeitslängen erhältlich

Bestellbar als einzelne Teile oder als Set



HOW TO ORDER A SET

Order your individual set by compiling the correct item number like this:

XXX - LL 03 - (1)YY

1. Jaw type:

Art No. for Set

2. Working Length

18 for 18 cm
 21 for 21 cm
 33 for 33 cm

3. MIS-Instrument:

03 for Ø3 mm
 2-part system

4. Handle:

Art No. for Set
 (optional) supplement with **1**
 means without HF-connection

1. Maultyp:

Art-Nr. für Set

2. Arbeitslänge:

18 für 18 cm
 21 für 21 cm
 33 für 33 cm

3. LAP-Instrument:

03 für Ø3 mm
 2-teiliges System

4. Griff:

Art-Nr. für Set
 (wahlweise) ergänzen mit **1**
 bedeutet ohne HF-Anschluss

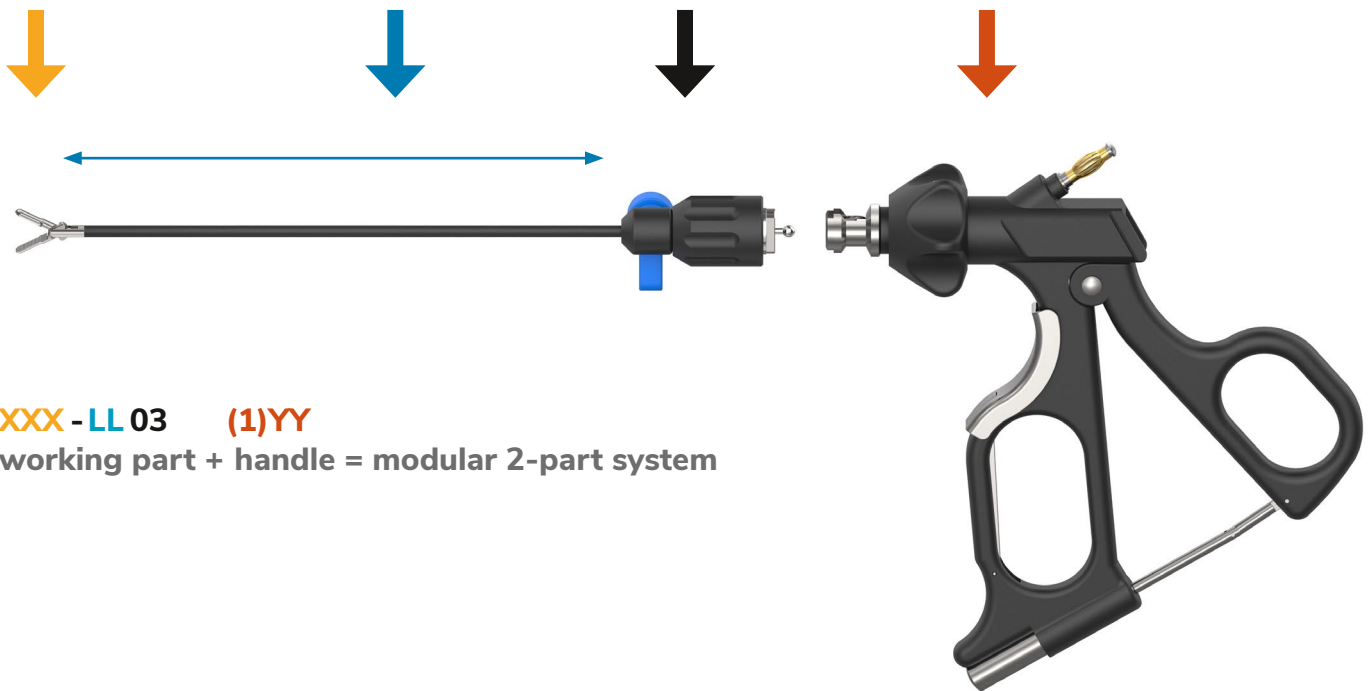

XXX - LL 03 (1)YY
 working part + handle = modular 2-part system

EXAMPLES

With HF-connection:

- ▶ XXX (Art No.) = 214
- ▶ LL (Length) = 18 (18 cm)
- ▶ 03 (Ø3 mm) = 03
- ▶ YY (Handle No.) = 84

Art No. =
214 - 18 03 - 84

Without HF-connection:

- ▶ XXX (Art No.) = 214
- ▶ LL (Length) = 21 (21 cm)
- ▶ 03 (Ø3 mm) = 03
- ▶ YYY (Handle No.) = 184

Art No. =
214 - 21 03 - 184

BEISPIELE

Mit HF-Anschluss:

- ▶ XXX (Insert Nr.) = 214
- ▶ LL (Länge) = 18 (18 cm)
- ▶ 03 (Ø3 mm) = 03
- ▶ YY (Griff Nr.) = 84

Art.-Nr. =
214 - 18 03 - 84

Ohne HF-Anschluss:

- ▶ XXX (insert Nr.) = 214
- ▶ LL (Länge) = 21 (21 cm)
- ▶ 03 (Ø3 mm) = 03
- ▶ YYY (Griff Nr.) = 184

Art.-Nr. =
214 - 21 03 - 184



ASSEMBLING

| 2-part system (modular), shaft-Ø 3 mm

MONTAGE

| 2-teiliges System (modular), Schaft-Ø 3 mm

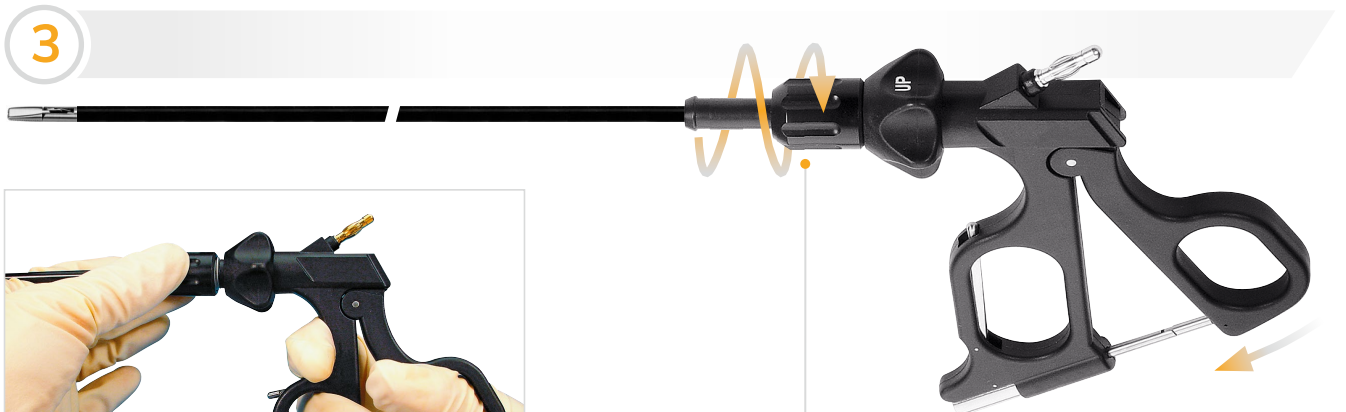
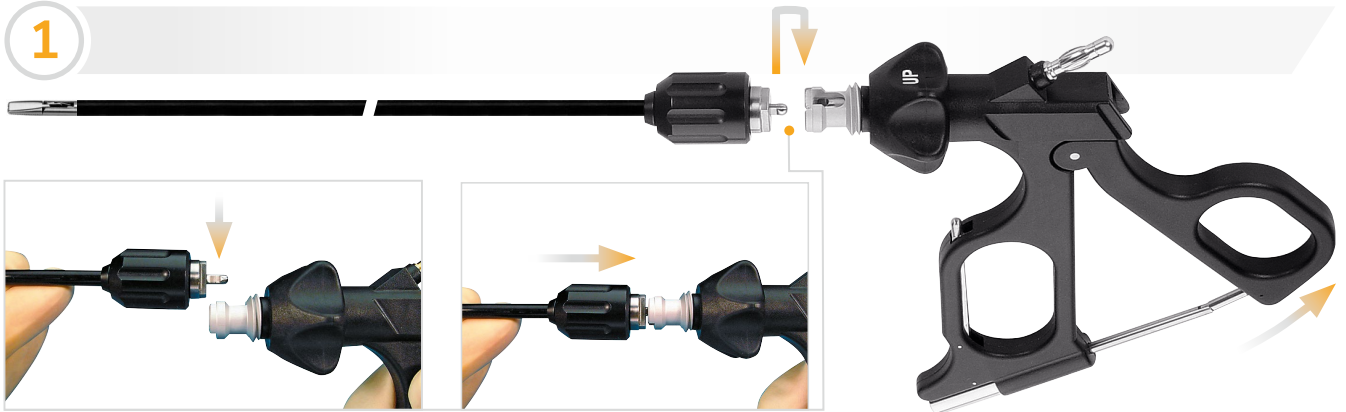



DISASSEMBLING

| 2-part system (modular), shaft-Ø 3 mm

DEMONTAGE



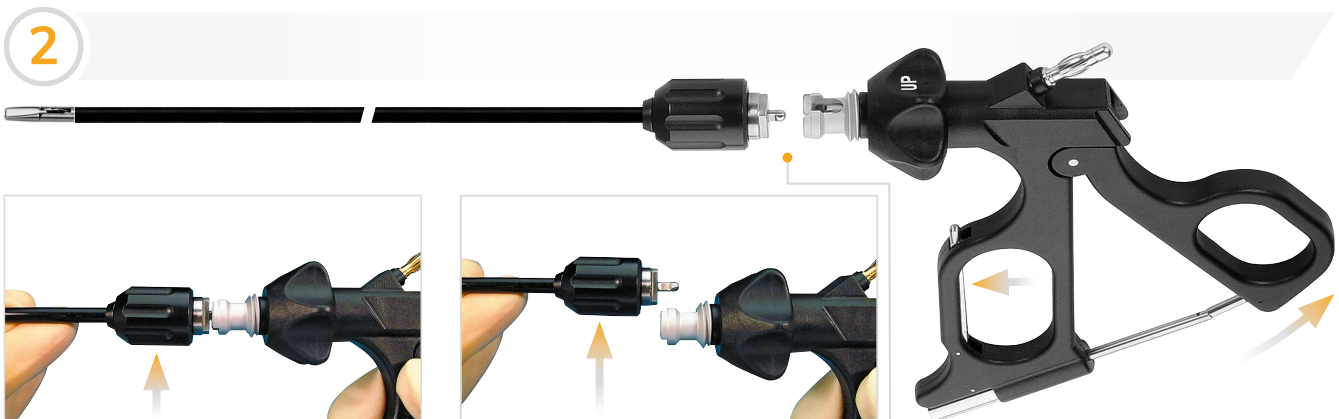
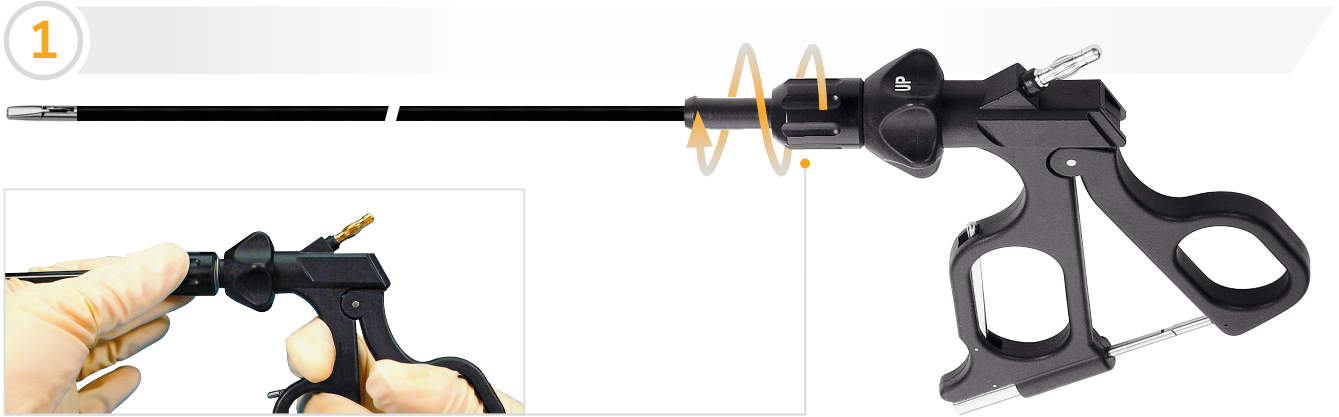



| 2-teiliges System (modular) , Schaft-Ø 3 mm





FORCEPS Ø 3 mm







GREIFER Ø 3 mm

| | Art No. for Set Art.-Nr. für Set | Art No. for single part Art.-Nr. für Einzelteil | Description Beschreibung |
|---|---|--|--|
|  | 209 | 300-209-1803 (18 cm) 300-209-2103 (21 cm) 300-209-3303 (33 cm) | Universal grasping forceps, jaw length 16 mm, double action jaws Universal-Fasszange, Maullänge 16 mm, doppelbeweglich |
|  | 210 | 300-210-1803 (18 cm) 300-210-2103 (21 cm) 300-210-3303 (33 cm) | Universal grasping forceps, jaw length 9 mm, double action jaws Universal-Fasszange, Maullänge 9 mm, doppelbeweglich |
|  | 212 | 300-212-1803 (18 cm) 300-212-2103 (21 cm) 300-212-3303 (33 cm) | MARYLAND grasping forceps, double action jaws MARYLAND Fasszange, doppelbeweglich |
|  | 213 | 300-213-1803 (18 cm) 300-213-2103 (21 cm) 300-213-3303 (33 cm) | Dissecting forceps, fenestrated, double action jaws Dissektions-Fasszange, gefenstert, doppelbeweglich |
|  | 214 | 300-214-1803 (18 cm) 300-214-2103 (21 cm) 300-214-3303 (33 cm) | Dissecting forceps, fenestrated, curved, double action jaws Dissektions-Fasszange, gefenstert, gebogen, doppelbeweglich |
|  | 220 | 300-220-1803 (18 cm) 300-220-2103 (21 cm) 300-220-3303 (33 cm) | Grasping forceps with reservoir, blunt, double action jaws Fasszange mit Reservoir, stumpf, doppelbeweglich |
|  | 222 | 300-222-1803 (18 cm) 300-222-2103 (21 cm) 300-222-3303 (33 cm) | Grasping forceps with reservoir, sharp, double action jaws Fasszange mit Reservoir, scharf, doppelbeweglich |



FORCEPS Ø 3 mm







GREIFER Ø 3 mm

| | Art No. for Set Art-Nr. für Set | Art No. for single part Art.-Nr. für Einzelteil | Description Beschreibung |
|---|--|--|---|
|  | 224 | 300-224-1803 (18 cm) 300-224-2103 (21 cm) 300-224-3303 (33 cm) | Grasping forceps "Dolphin", double action jaws Fassungzange „Delphin“, doppelbeweglich |
|  | 227 | 300-227-1803 (18 cm) 300-227-2103 (21 cm) 300-227-3303 (33 cm) | MARYLAND grasping forceps, crosswise teeth, long, double action jaws MARYLAND Fassungzange, kreuzverzahnt, lang, doppelbeweglich |
|  | 230 | 300-230-1803 (18 cm) 300-230-2103 (21 cm) 300-230-3303 (33 cm) | Grasping forceps sharp, crosswise teeth, jaw length 12 mm, double action jaws Fassungzange scharf, Kreuzverzahnung, Maullänge 12 mm, doppelbeweglich |
|  | 242 | 300-242-1803 (18 cm) 300-242-2103 (21 cm) 300-242-3303 (33 cm) | Claw grasping and extracting forceps, 2+3 teeth, single action jaws Krallengreifzange, 2+3 Zähne, einfachbeweglich |
|  | 246 | 300-246-1803 (18 cm) 300-246-2103 (21 cm) 300-246-3303 (33 cm) | Extracting forceps with a row of retrograde teeth, double action jaws Extraktionszange, retrograde Zahnreihe, doppelbeweglich |
|  | 258 | 300-258-1803 (18 cm) 300-258-2103 (21 cm) 300-258-3303 (33 cm) | MIXTER grasping forceps, 90° gewinkelt, double action jaws MIXTER Fassungzange, 90° angled, doppelbeweglich |
|  | 261 | 300-261-1803 (18 cm) 300-261-2103 (21 cm) 300-261-3303 (33 cm) | JOHANN Dissecting and grasping forceps, double action jaws JOHANN Präparier- und Fassungzange, doppelbeweglich |



FORCEPS Ø 3 mm



GREIFER Ø 3 mm

| | Art No. for Set Art.-Nr. für Set | Art No. for single part Art.-Nr. für Einzelteil | Description Beschreibung |
|---|-------------------------------------|--|---|
|  | 266 | 300-266-1803 (18 cm) 300-266-2103 (21 cm) 300-266-3303 (33 cm) | KELLY Dissector, double action jaws KELLY Dissektor, doppelbeweglich |
|  | 267 | 300-267-1803 (18 cm) 300-267-2103 (21 cm) 300-267-3303 (33 cm) | JOHANN dissecting and grasping forceps, fenestrated, single action jaws JOHANN Präparier- und Fassungzange, gefenstert, einfachbeweglich |
|  | 270 | 300-270-1803 (18 cm) 300-270-2103 (21 cm) 300-270-3303 (33 cm) | BABCOCK clamp, fenestrated, double action jaws BABCOCK Klemme, gefenstert, doppelbeweglich |
|  | 284 | 300-284-1803 (18 cm) 300-284-2103 (21 cm) 300-284-3303 (33 cm) | Tenaculum grasping forceps, double action jaws Tenakulum-Fassungzange, doppelbeweglich |
|  | 293 | 300-293-1803 (18 cm) 300-293-2103 (21 cm) 300-293-3303 (33 cm) | Atraumatic grasping forceps, with wavy teeth and reservoir, single action jaws Atraumatische Fassungzange mit gewellten Zähnen und Reservoir, einfachbeweglich |
|  | 520 | 300-520-1803 (18 cm) 300-520-2103 (21 cm) 300-520-3303 (33 cm) | DeBAKEY grasping forceps, double action jaws DeBAKEY Fassungzange, doppelbeweglich |
|  | 542 | 300-542-1803 (18 cm) 300-542-2103 (21 cm) 300-542-3303 (33 cm) | ALLIS grasping forceps, double action jaws ALLIS Fassungzange, doppelbeweglich |



BIOPSY CUPS Ø 3 mm

BIOPSIE LÖFFEL Ø 3 mm

| Art No. for Set Art-Nr. für Set | Art No. for single part Art.-Nr. für Einzelteil | Description Beschreibung |
|--|--|---|
|  1/1 | 310 300-310-1803 (18 cm) 300-310-2103 (21 cm) 300-310-3303 (33 cm) | Biopsy cup without thorn, double action jaws Biopsie-Löffel ohne Dorn, doppelbeweglich |
|  1/1 | 312 300-312-1803 (18 cm) 300-312-2103 (21 cm) 300-312-3303 (33 cm) | Biopsy cup with thorn, double action jaws Biopsie-Löffel mit Dorn, doppelbeweglich |



... if it's quality that you expect!

MODULAR SYSTEM

Can be ordered in 3 different lengths.

MODULARES SYSTEM

In 3 verschiedenen Längen bestellbar.



MICROLAP Ø 3 mm

Each insert is available in three working lengths and with flushing connection.

MICROLAP Ø 3 mm



Jeder Aufsatz ist in drei Arbeitslängen und mit Spülanschluss verfügbar

SCISSORS Ø 3 mm

Scissors sets can only be ordered with handle no. 52, 62,84 und 184.

SCHEREN Ø 3 mm

Scheren-Sets können nur für die **Griffe Nr. 52, 62,84 und 184** bestellt werden.

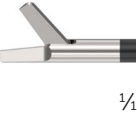
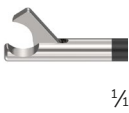
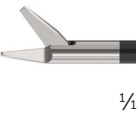
| | Art No. for Set Art-Nr. für Set | Art No. for single part Art.-Nr. für Einzelteil | Description Beschreibung |
|--|------------------------------------|--|--|
|  1/1 | 110 | 300-110-1803 (18 cm) 300-110-2103 (21 cm) 300-110-3303 (33 cm) | Preparation scissors, double action jaws Präparier-Schere, doppelbeweglich |
|  1/1 | 112 | 300-112-1803 (18 cm) 300-112-2103 (21 cm) 300-112-3303 (33 cm) | METZENBAUM preparation scissors, curved, double action jaws METZENBAUM Präparier-Schere, gebogen, doppelbeweglich |
|  1/1 | 114 | 300-114-1803 (18 cm) 300-114-2103 (21 cm) 300-114-3303 (33 cm) | Micro peritoneal scissors, single action jaws Mikro-Peritonalschere, einfachbeweglich |
|  1/1 | 116 | 300-116-1803 (18 cm) 300-116-2103 (21 cm) 300-116-3303 (33 cm) | Hook scissors, single action jaws Hakenschere, einfachbeweglich |
|  1/1 | 118 | 300-118-1803 (18 cm) 300-118-2103 (21 cm) 300-118-3303 (33 cm) | Micro scissors, single action jaws Micro-Schere, einfachbeweglich |







NEEDLE HOLDERS Ø 3 mm

Needle holders sets can only be ordered with
 handle no. 50, 60, 70, 180, 181, 182 and 185.

NADELHALTER Ø 3 mm

Nadelhalter-Sets können nur für die Griffe Nr. 50, 60, 70,
 180, 181, 182 und 185 bestellt werden.

| | Art No. for Set Art-Nr. für Set | Art No. for single part Art-Nr. für Einzelteil | Description Beschreibung |
|---|--|--|---|
|  | 350 | 300-350-1803 (18 cm) 300-350-2103 (21 cm) 300-350-3303 (33 cm) | Straight with TC insert, crosswise teeth, single action jaws Gerade mit Hartmetalleinlagen, kreuzverzahnt, einfachbeweglich |
|  | 352 | 300-352-1803 (18 cm) 300-352-2103 (21 cm) 300-352-3303 (33 cm) | Left curved with TC insert, crosswise teeth, single action jaws Links gebogen mit Hartmetalleinlagen, kreuzverzahnt, einfachbeweglich |
|  | 354 | 300-354-1803 (18 cm) 300-354-2103 (21 cm) 300-354-3303 (33 cm) | Right curved with TC insert, crosswise teeth, single action jaws Rechts gebogen mit Hartmetalleinlagen, kreuzverzahnt, einfachbeweglich |
|  | 360 | 300-360-1803 (18 cm) 300-360-2103 (21 cm) 300-360-3303 (33 cm) | Needle holder/-positioner, convex/concave shaped jaws with fixation teeth, with wolfram-carbide-coated tips, single action jaws Nadelhalter -positionierer, konvex/konvav geformte Maulform mit Fixierzähnen, Greifflächen mit Wolfram-Karbid-Beschichtung, einfachbeweglich |



LAPAROSCOPY INSTRUMENTS Ø 5 mm

LAPAROSKOPIE-INSTRUMENTE Ø 5 mm



3-part system (modular)

With or without flushing connection

Available in four working lengths

Ø 10 mm tube shafts available for Ø 5 mm inserts

Can be ordered as single parts or as a set

3-teiliges System (modular)

Mit oder ohne Spülanschluss

In vier Arbeitslängen erhältlich

Ø 10 mm Rohrschäfte für Ø 5 mm Einsätze erhältlich

Bestellbar als einzelne Teile oder als Set



HOW TO ORDER A SET

Order your individual set by compiling the correct item number like this:

EIN SET BESTELLEN

Um ihr individuelles Set zu bestellen setzen Sie die Artikelnummer wie folgt zusammen:

XXX - LL XX (L) - (1)YY

| | | | | |
|--|---|--|---|--|
| 1. Jaw / Insert: Art No. for Set | 2. Working Length: 25 for 25 cm 33 for 33 cm 36 for 36 cm 45 for 45 cm | 3. MIS-Instrument: 05 for Ø 5 mm resp. 10 for Ø 10 mm 3-part system | 4. flushing-connection: (optional) Supplement L for flushing-connection | 5. Handle: Art No. for Set (optional) Supplement with 1 means without HF-connection |
|--|---|--|---|--|

| | | | | |
|--|---|---|--|--|
| 1. Maul / Einsatz: Art-Nr. für Set | 2. Arbeitslänge: 25 für 25 cm 33 für 33 cm 36 für 36 cm 45 für 45 cm | 3. LAP-Instrument: 05 für Ø 5 mm bzw. 10 für Ø 10 mm 3-teiliges System | 4. Spülanschluss: (wahlweise) Ergänzen mit L für Spülanschluss | 5. Griff: Art-Nr. für Set (wahlweise) Ergänzen mit 1 bedeutet ohne HF-Anschluss |
|--|---|---|--|--|

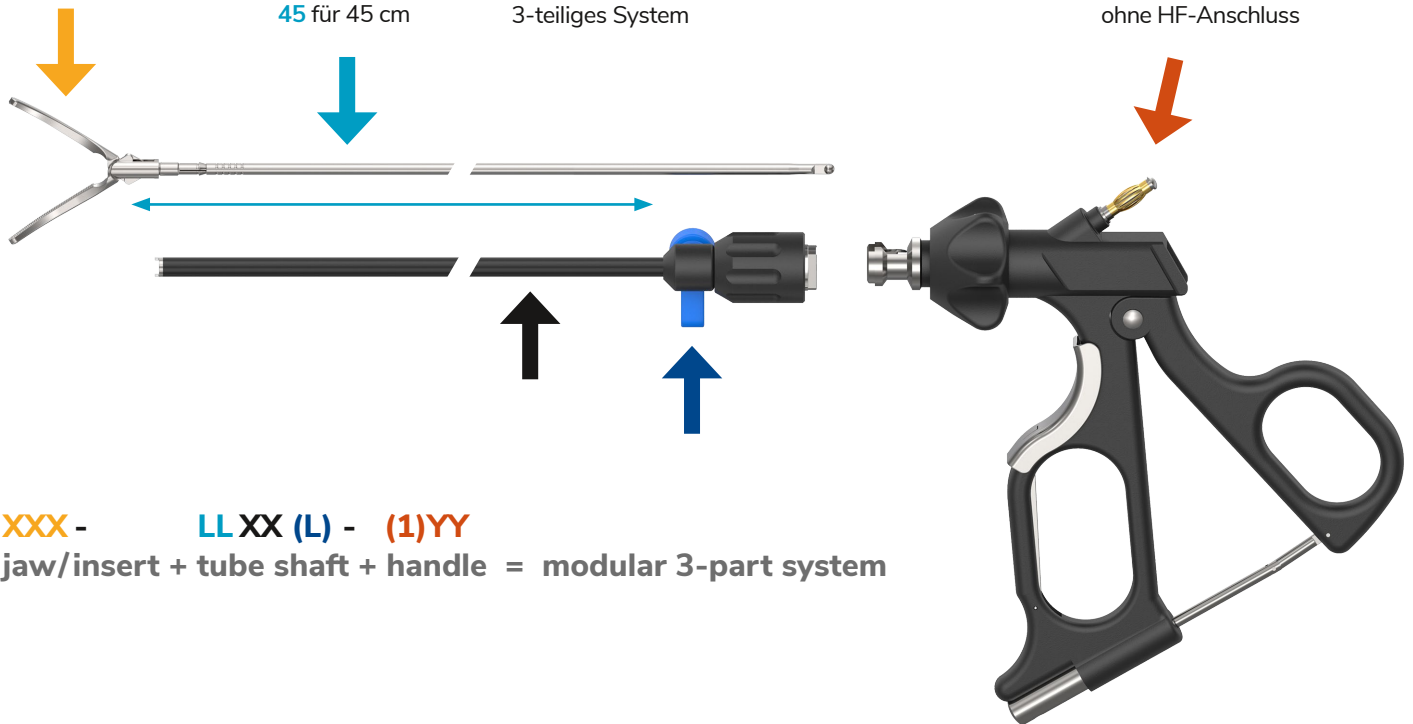

XXX - LL XX (L) - (1)YY
 jaw/insert + tube shaft + handle = modular 3-part system

EXAMPLES

With HF-connection,
with flushing connection:

- ▶ XXX (Art No.) = 286
- ▶ LL (Length) = 33 (33 cm)
- ▶ 05 (Ø5 mm) = 05
- ▶ L (flushing con.) = L
- ▶ YY (Handle No.) = 84

Art No. =
286 - 33 XL - 84

Without HF-connection,
without flushing connection:

- ▶ XXX (Art No.) = 286
- ▶ LL (Length) = 36 (36 cm)
- ▶ 05 (Ø5 mm) = 05
- ▶ YYY (Handle No.) = 184

Art No. =
286 - 36 XX - 184

BEISPIELE

Mit HF-Anschluss,
mit Spülanschluss:

- ▶ XXX (Art-Nr.) = 286
- ▶ LL (Länge) = 33 (33 cm)
- ▶ 05 (Ø5 mm) = 05
- ▶ L (Spülanschluss) = L
- ▶ YY (Griff Nr.) = 84

Art.-Nr. =
286 - 33 XL - 84

Ohne HF-Anschluss,
ohne Spülanschluss:

- ▶ XXX (Art-Nr.) = 286
- ▶ LL (Länge) = 36 (36 cm)
- ▶ 05 (Ø5 mm) = 05
- ▶ YYY (Griff Nr.) = 184

Art.-Nr. =
286 - 36 XX - 184



ASSEMBLING

| 3-part system (modular), shaft-Ø 5 und 10 mm

MONTAGE

| 3-teiliges System (modular), Schaft-Ø 5 und 10 mm

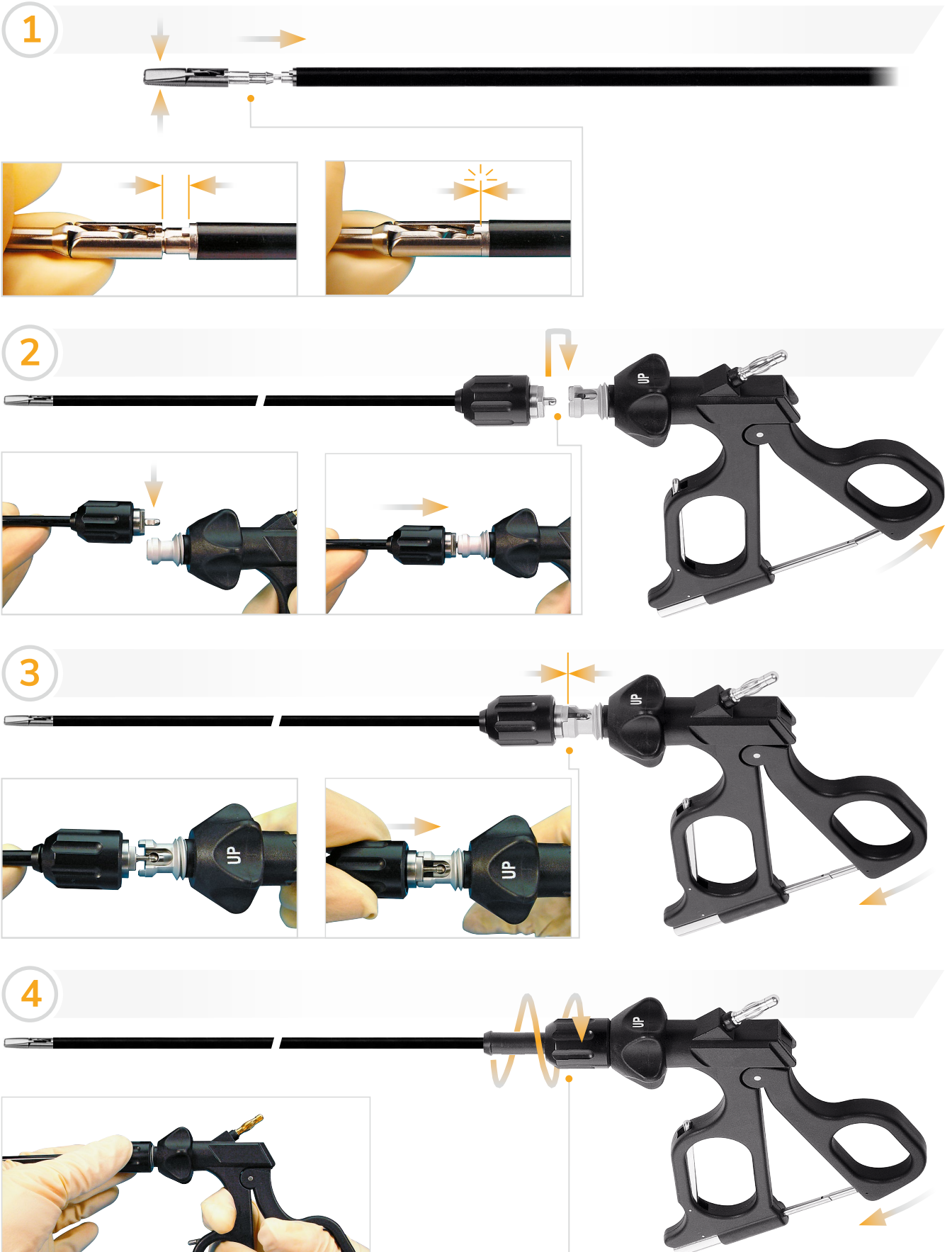



DISASSEMBLING

| 3-part system (modular), shaft-Ø 5 und 10 mm

DEMONTAGE

| 3-teiliges System (modular) Schaft-Ø 5 und 10 mm

1

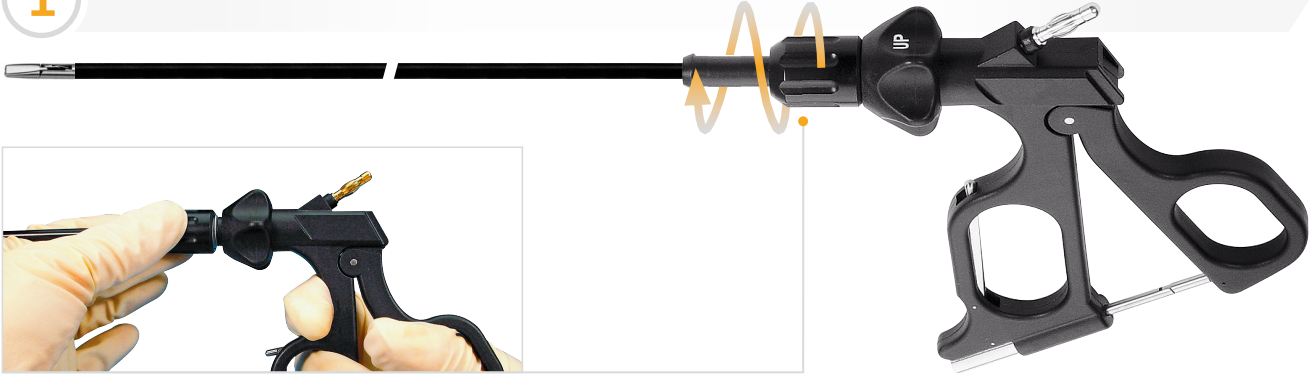

2

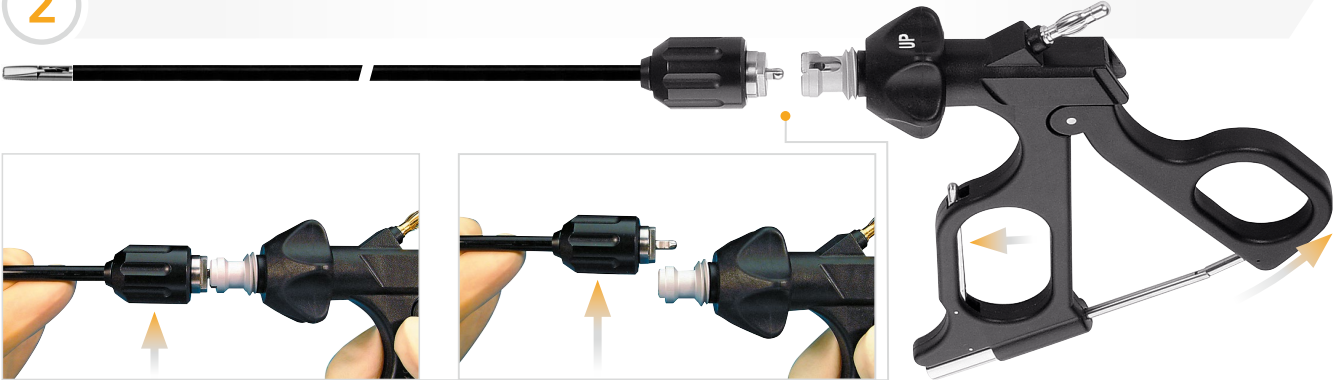

3

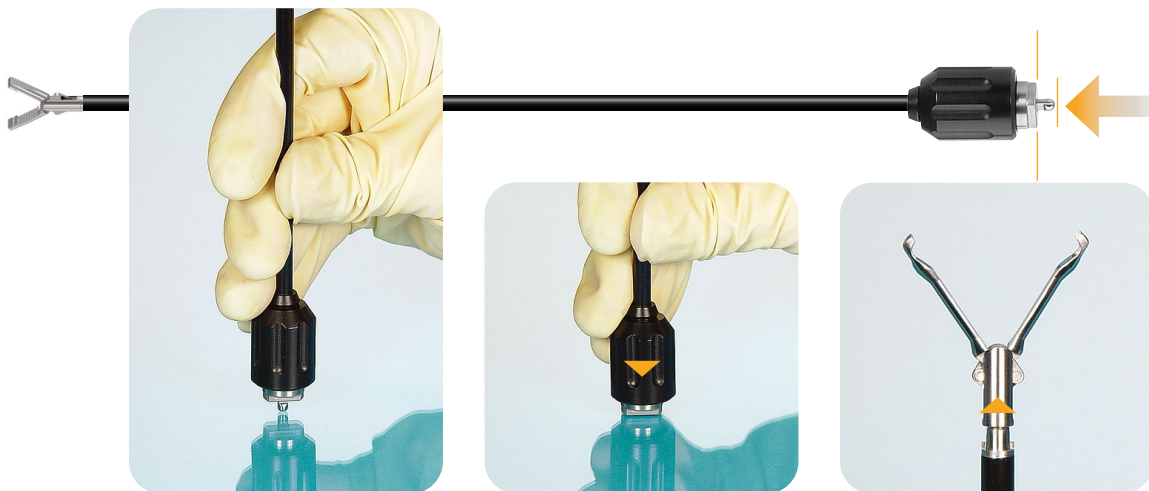

4





MODULAR TUBE SHAFTS

Available in four working lengths,
with or without flushing connection.

MODULARE ROHRSCHÄFTE

In vier Arbeitslängen, mit
oder ohne Spülanschluss
erhältlich.





TUBE SHAFTS Ø 5 mm

ROHRSCHÄFTE Ø 5 mm

| Working Length Arbeitslänge | Art No. for single part Art.-Nr. für Einzelteil | Description Beschreibung |
|--------------------------------|--|-----------------------------|
| 25 cm | 300-100-2505 | |
| 33 cm | 300-100-3305 | without flushing connection |
| 36 cm | 300-100-3605 | ohne Spülanschluss |
| 45 cm | 300-100-4505 | |
| 25 cm | 300-100-2505L | |
| 33 cm | 300-100-3305L | with flushing connection |
| 36 cm | 300-100-3605L | mit Spülanschluss |
| 45 cm | 300-100-4505L | |



TUBE SHAFTS Ø 10 mm REDUCED TO Ø 5 mm

ROHRSCHÄFTE Ø 10 mm REDUZIERT AUF Ø 5 mm

| Working Length Arbeitslänge | Art No. for single part Art.-Nr. für Einzelteil | Description Beschreibung |
|--------------------------------|--|-----------------------------|
| 33 cm | 300-100-3310-5 | |
| 36 cm | 300-100-3610-5 | without flushing connection |
| 45 cm | 300-100-4510-5 | ohne Spülanschluss |
| 33 cm | 300-100-3310-5L | |
| 36 cm | 300-100-3610-5L | with flushing connection |
| 45 cm | 300-100-4510-5L | mit Spülanschluss |





INSERTS Ø 5 mm

LL = Length = 25 cm, 33 cm, 36 cm, 45 cm
 (Each insert is available in four working lengths)

EINSÄTZE Ø 5 mm



LL = Länge = 25 cm, 33 cm, 36 cm, 45 cm
 (Jeder Einsatz ist in vier Arbeitslängen verfügbar.)

SCISSORS Ø 5 mm

Scissors sets can only be ordered with
 handle no. 52, 62, 84 und 184.

SCHEREN Ø 5 mm

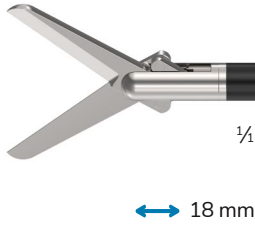
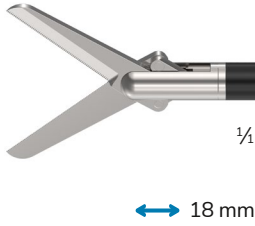
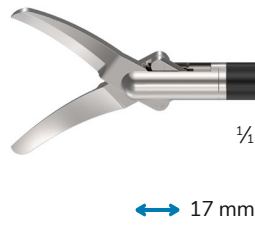
Scheren-Sets können nur für die Griffe Nr. 52, 62, 84 und
 184 bestellt werden.

| | Art No. for Set Art.-Nr. für Set | Art No. for single part Art.-Nr. für Einzelteil | Description Beschreibung |
|---|-------------------------------------|--|--|
|  | 110 | 300-110-2505 (25 cm) 300-110-3305 (33 cm) 300-110-3605 (36 cm) 300-110-4505 (45 cm) | Preparation scissors, double action jaws Präparier-Schere, doppelbeweglich |
|  | 111 | 300-111-2505 (25 cm) 300-111-3305 (33 cm) 300-111-3605 (36 cm) 300-111-4505 (45 cm) | Endo scissors "Supercut", serrated, double action jaws Endo-Schere „Supercut“, fein gezahnt, doppelbeweglich |
|  | 112 | 300-112-2505 (25 cm) 300-112-3305 (33 cm) 300-112-3605 (36 cm) 300-112-4505 (45 cm) | METZENBAUM Scissors, curved, double action jaws METZENBAUM-Schere, gebogen, doppelbeweglich |
|  | 113 | 300-113-2505 (25 cm) 300-113-3305 (33 cm) 300-113-3605 (36 cm) 300-113-4505 (45 cm) | METZENBAUM Scissors "Wondercut", curved, double action jaws METZENBAUM-Schere „Wondercut“, gebogen, doppelbeweglich |







SCISSORS Ø 5 mm

Scissors sets can only be ordered with
handle no. 52, 62, 84 und 184.

SCHEREN Ø 5 mm

Scheren-Sets können nur für die **Griffe Nr. 52, 62, 84 und 184** bestellt werden.

| | Art No. for Set Art-Nr. für Set | Art No. for single part Art.-Nr. für Einzelteil | Description Beschreibung |
|---|------------------------------------|--|--|
|  <p>1/4 ↔ 10,5 mm</p> | 114 | 300-114-2505 (25 cm) 300-114-3305 (33 cm) 300-114-3605 (36 cm) 300-114-4505 (45 cm) | Peritoneal scissors, single action jaws Peritoneal-Schere, einfachbeweglich |
|  <p>1/4 ↔ 11 mm</p> | 115 | 300-115-2505 (25 cm) 300-115-3305 (33 cm) 300-115-3605 (36 cm) 300-115-4505 (45 cm) | Peritoneal scissors, slim, single action jaws Peritoneal-Schere, schlank, einfachbeweglich |
|  <p>1/4 ↔ 9 mm</p> | 116 | 300-116-2505 (25 cm) 300-116-3305 (33 cm) 300-116-3605 (36 cm) 300-116-4505 (45 cm) | Hook scissors, single action jaws Hakenschere, einfachbeweglich |
|  <p>1/4 ↔ 5,5 mm</p> | 118 | 300-118-2505 (25 cm) 300-118-3305 (33 cm) 300-118-3605 (36 cm) 300-118-4505 (45 cm) | Micro scissors, single action jaws Micro-Schere, einfachbeweglich |
|  <p>1/4 ↔ 12 mm</p> | 119 | 300-119-2505 (25 cm) 300-119-3305 (33 cm) 300-119-3605 (36 cm) 300-119-4505 (45 cm) | METZENBAUM baby scissors, curved, double action jaws METZENBAUM Baby-Schere, gebogen, doppelbeweglich |







SCISSORS Ø 5 mm

Scissors sets can only be ordered with
handle no. 52, 62, 84 und 184.

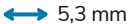

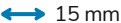
SCHEREN Ø 5 mm

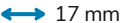
Scheren-Sets können nur für die **Griffe Nr. 52, 62, 84 und 184** bestellt werden.

| | Art No. for Set Art.-Nr. für Set | Art No. for single part Art.-Nr. für Einzelteil | Description Beschreibung |
|---|-------------------------------------|--|---|
|  $\frac{1}{4}$  5,3 mm | 120 | 300-120-2505 (25 cm) 300-120-3305 (33 cm) 300-120-3605 (36 cm) 300-120-4505 (45 cm) | Micro scissors, curved, single action jaws Mikro-Schere, gebogen, einfachbeweglich |
|  $\frac{1}{4}$  15 mm | 121 | 300-121-2505 (25 cm) 300-121-3305 (33 cm) 300-121-3605 (36 cm) 300-121-4505 (45 cm) | Mini scissors, curved, double action jaws Mini-Schere, gebogen, doppelbeweglich |
|  $\frac{1}{4}$  17 mm | 125 | 300-125-2505 (25 cm) 300-125-3305 (33 cm) 300-125-3605 (36 cm) 300-125-4505 (45 cm) | METZENBAUM Preparation scissors, toothed, reinforced version, curved, double action jaws METZENBAUM Präparier-Schere, gezahnt, verstärkte Ausführung, gebogen, doppelbeweglich |

FORCEPS Ø 5 mm

GREIFER Ø 5 mm

| | Art No. for Set Art.-Nr. für Set | Art No. for single part Art.-Nr. für Einzelteil | Description Beschreibung |
|---|-------------------------------------|--|--|
|  $\frac{1}{4}$  17,5 mm | 210 | 300-210-2505 (25 cm) 300-210-3305 (33 cm) 300-210-3605 (36 cm) 300-210-4505 (45 cm) | Universal grasping forceps, double action jaws Universal-Fasszange, doppelbeweglich |



FORCEPS Ø 5 mm





GREIFER Ø 5 mm

| | Art No. for Set Art.-Nr. für Set | Art No. for single part Art.-Nr. für Einzelteil | Description Beschreibung |
|--|-------------------------------------|--|--|
| | 276 | 300-276-2505 (25 cm) 300-276-3305 (33 cm) 300-276-3605 (36 cm) 300-276-4505 (45 cm) | Universal grasping forceps "Maxi Grip", double action jaws Universal-Fasszange „Maxi Grip“, doppelbeweglich |
| | 211 | 300-211-2505 (25 cm) 300-211-3305 (33 cm) 300-211-3605 (36 cm) 300-211-4505 (45 cm) | MARYLAND grasping forceps conical, double action jaws MARYLAND Fasszange konisch, doppelbeweglich |
| | 212 | 300-212-2505 (25 cm) 300-212-3305 (33 cm) 300-212-3605 (36 cm) 300-212-4505 (45 cm) | MARYLAND grasping forceps, double action jaws MARYLAND Fasszange, doppelbeweglich |
| | 286 | 300-286-2505 (25 cm) 300-286-3305 (33 cm) 300-286-3605 (36 cm) 300-286-4505 (45 cm) | MARYLAND grasping forceps, DeBAKEY teeth, double action jaws MARYLAND Fasszange, DeBAKEY-Zahnung, doppelbeweglich |
| | 287 | 300-287-2505 (25 cm) 300-287-3305 (33 cm) 300-287-3605 (36 cm) 300-287-4505 (45 cm) | Long MARYLAND grasping forceps, double action jaws Lange MARYLAND Fasszange, doppelbeweglich |



FORCEPS Ø 5 mm

GREIFER Ø 5 mm

| | Art No. for Set Art.-Nr. für Set | Art No. for single part Art.-Nr. für Einzelteil | Description Beschreibung |
|---|-------------------------------------|--|--|
|  <p>1/4</p> <p>↔ 11 mm</p> | 266 | 300-266-2505 (25 cm) 300-266-3305 (33 cm) 300-266-3605 (36 cm) 300-266-4505 (45 cm) | KELLY Grasping forceps, double action jaws KELLY Fassungzange, doppelbeweglich |
|  <p>1/4</p> <p>↔ 20 mm</p> | 294 | 300-294-2505 (25 cm) 300-294-3305 (33 cm) 300-294-3605 (36 cm) 300-294-4505 (45 cm) | Long KELLY grasping forceps, crosswise teeth, double action jaws Lange KELLY Fassungzange, kreuzverzahnt, doppelbeweglich |
|  <p>1/4</p> <p>↔ 16 mm</p> | 213 | 300-213-2505 (25 cm) 300-213-3305 (33 cm) 300-213-3605 (36 cm) 300-213-4505 (45 cm) | Dissection forceps, fenestrated, double action jaws Dissektions-Fassungzange, gefenstert, doppelbeweglich |
|  <p>1/4</p> <p>↔ 19,5 mm</p> | 214 | 300-214-2505 (25 cm) 300-214-3305 (33 cm) 300-214-3605 (36 cm) 300-214-4505 (45 cm) | Dissecting forceps, fenestrated, double action jaws Dissektions-Fassungzange, gefenstert, doppelbeweglich |
|  <p>1/4</p> <p>↔ 15 mm</p> | 215 | 300-215-2505 (25 cm) 300-215-3305 (33 cm) 300-215-3605 (36 cm) 300-215-4505 (45 cm) | Grasping forceps "Duck Bill", fenestrated, single action jaws Fassungzange „Duck Bill“, gefenstert, einfachbeweglich |



FORCEPS Ø 5 mm



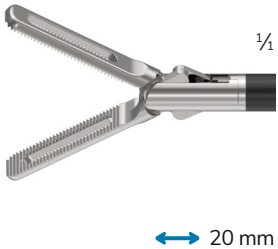
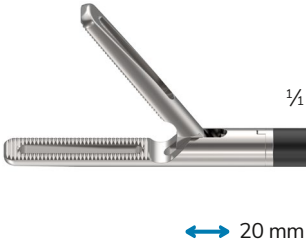
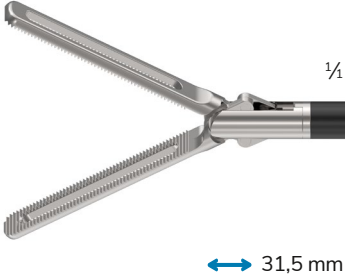
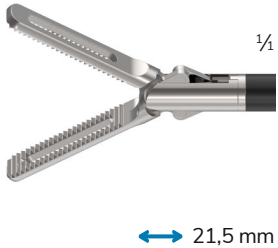
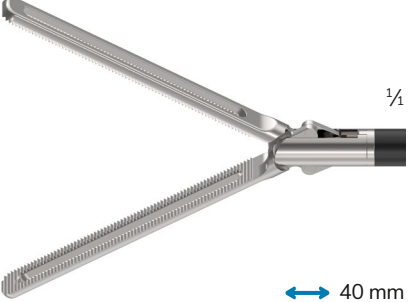

GREIFER Ø 5 mm

| | Art No. for Set Art.-Nr. für Set | Art No. for single part Art.-Nr. für Einzelteil | Description Beschreibung |
|--|-------------------------------------|--|---|
|  <p>20 mm</p> | 248 | 300-248-2505 (25 cm) 300-248-3305 (33 cm) 300-248-3605 (36 cm) 300-248-4505 (45 cm) | DORSEY bowel grasping forceps, fenestrated, double action jaws DORSEY Darmfasszange, gefenstert, doppelbeweglich |
|  <p>20 mm</p> | 249 | 300-249-2505 (25 cm) 300-249-3305 (33 cm) 300-249-3605 (36 cm) 300-249-4505 (45 cm) | Retraction-/Dissecting forceps, fenestrated, single action jaws Greif-/Dissektionszange, gefenstert, einfachbeweglich |
|  <p>31,5 mm</p> | 255 | 300-255-2505 (25 cm) 300-255-3305 (33 cm) 300-255-3605 (36 cm) 300-255-4505 (45 cm) | DORSEY bowel grasping forceps, fenestrated, double action jaws DORSEY Darmfasszange, gefenstert, doppelbeweglich |
|  <p>21,5 mm</p> | 261 | 300-261-2505 (25 cm) 300-261-3305 (33 cm) 300-261-3605 (36 cm) 300-261-4505 (45 cm) | JOHANN Preparation- and grasping forceps, fenestrated, double action jaws JOHANN Präparier- und Fasszange, gefenstert, doppelbeweglich |
|  <p>40 mm</p> | 262 | 300-262-2505 (25 cm) 300-262-3305 (33 cm) 300-262-3605 (36 cm) 300-262-4505 (45 cm) | Long DORSEY bowel grasping forceps, fenestrated, double action jaws Lange DORSEY Darmfasszange, gefenstert, doppelbeweglich |

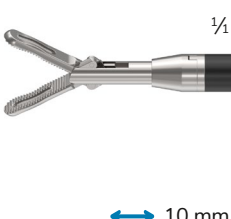

FORCEPS Ø 5 mm

GREIFER Ø 5 mm

| | Art No. for Set Art.-Nr. für Set | Art No. for single part Art.-Nr. für Einzelteil | Description Beschreibung |
|---|-------------------------------------|--|---|
|  | 263 | 300-263-2505 (25 cm) 300-263-3305 (33 cm) 300-263-3605 (36 cm) 300-263-4505 (45 cm) | Grasping forceps, fenestrated, single action jaws Fasszange, gefenstert, einfachbeweglich |
|  | 267 | 300-267-2505 (25 cm) 300-267-3305 (33 cm) 300-267-3605 (36 cm) 300-267-4505 (45 cm) | Grasping forceps, rough tooth pitch, 90°, fenestrated, double action jaws Fasszange, grobe Zahnteilung, 90°, gefenstert, doppelbeweglich |
|  | 296 | 300-296-2505 (25 cm) 300-296-3305 (33 cm) 300-296-3605 (36 cm) 300-296-4505 (45 cm) | Strong grasping forceps, fenestrated, double action jaws Starke Fasszange, gefenstert, doppelbeweglich |
|  | 216 | 300-216-2505 (25 cm) 300-216-3305 (33 cm) 300-216-3605 (36 cm) 300-216-4505 (45 cm) | Dissecting forceps slim, fenestrated, double action jaws Dissektions-Fasszange schmal, gefenstert, doppelbeweglich |
|  | 217 | 300-217-2505 (25 cm) 300-217-3305 (33 cm) 300-217-3605 (36 cm) 300-217-4505 (45 cm) | Dissection forceps, fenestrated, double action jaws Dissektions-Fasszange, gefenstert, doppelbeweglich |



FORCEPS Ø 5 mm



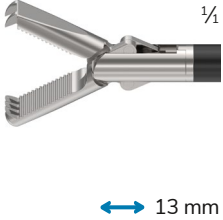
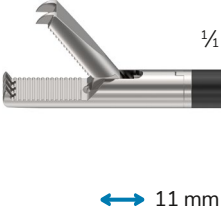
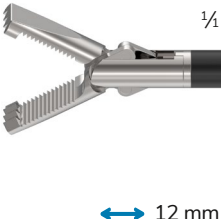
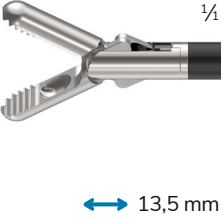
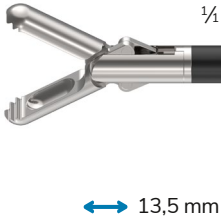

GREIFER Ø 5 mm

| | Art No. for Set Art.-Nr. für Set | Art No. for single part Art.-Nr. für Einzelteil | Description Beschreibung |
|---|-------------------------------------|--|--|
|  | 218 | 300-218-2505 (25 cm) 300-218-3305 (33 cm) 300-218-3605 (36 cm) 300-218-4505 (45 cm) | Grasping forceps with 2 + 4 teeth, double action jaws Fassungzange mit 2 + 4 Zähnen, doppelbeweglich |
|  | 219 | 300-219-2505 (25 cm) 300-219-3305 (33 cm) 300-219-3605 (36 cm) 300-219-4505 (45 cm) | Grasping forceps with 2 + 4 teeth, single action jaws Fassungzange mit 2 + 4 Zähnen, einfachbeweglich |
|  | 295 | 300-295-2505 (25 cm) 300-295-3305 (33 cm) 300-295-3605 (36 cm) 300-295-4505 (45 cm) | ALLIS grasping forceps, double action jaws ALLIS Fassungzange, doppelbeweglich |
|  | 220 | 300-220-2505 (25 cm) 300-220-3305 (33 cm) 300-220-3605 (36 cm) 300-220-4505 (45 cm) | Grasping forceps with small reservoir, double action jaws Fassungzange mit kleinem Reservoir, doppelbeweglich |
|  | 221 | 300-221-2505 (25 cm) 300-221-3305 (33 cm) 300-221-3605 (36 cm) 300-221-4505 (45 cm) | Grasping forceps with big reservoir, double action jaws Fassungzange mit großem Reservoir, doppelbeweglich |

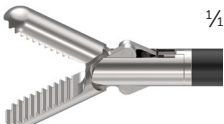

FORCEPS Ø 5 mm

GREIFER Ø 5 mm

| | Art No. for Set Art.-Nr. für Set | Art No. for single part Art.-Nr. für Einzelteil | Description Beschreibung |
|---|-------------------------------------|--|---|
|  <p>1/1</p> <p>↔ 13,5 mm</p> | 222 | 300-222-2505 (25 cm) 300-222-3305 (33 cm) 300-222-3605 (36 cm) 300-222-4505 (45 cm) | Grasping forceps with reservoir, sharp, double action jaws Fasszange mit Reservoir, spitz, doppelbeweglich |
|  <p>1/1</p> <p>↔ 9,5 mm</p> | 236 | 300-236-2505 (25 cm) 300-236-3305 (33 cm) 300-236-3605 (36 cm) 300-236-4505 (45 cm) | Grasping forceps, double action jaws Fasszange, doppelbeweglich |
|  <p>1/1</p> <p>↔ 13,5 mm</p> | 260 | 300-260-2505 (25 cm) 300-260-3305 (33 cm) 300-260-3605 (36 cm) 300-260-4505 (45 cm) | REDDICK-OLSEN grasping forceps "Duck Bill", double action jaws REDDICK-OLSEN Fasszange "Entenschnabel", doppelbeweglich |
|  <p>1/1</p> <p>↔ 16 mm</p> | 278 | 300-278-2505 (25 cm) 300-278-3305 (33 cm) 300-278-3605 (36 cm) 300-278-4505 (45 cm) | Grasping forceps, round / flat, double action jaws Fasszange, rund / flach, doppelbeweglich |
|  <p>1/1</p> <p>↔ 23 mm</p> | 288 | 300-288-2505 (25 cm) 300-288-3305 (33 cm) 300-288-3605 (36 cm) 300-288-4505 (45 cm) | HUNTER bowel grasping forceps, teeth fine grooved, fenestrated, double action jaws HUNTER Darmfasszange, Zahnung fein gerieft, gefenstert, doppelbeweglich |



FORCEPS Ø 5 mm





GREIFER Ø 5 mm

| | Art No. for Set Art.-Nr. für Set | Art No. for single part Art.-Nr. für Einzelteil | Description Beschreibung |
|------------------------|---|--|--|
| <p>1/1 24 mm</p> | 289 | 300-289-2505 (25 cm) 300-289-3305 (33 cm) 300-289-3605 (36 cm) 300-289-4505 (45 cm) | HUNTER bowel grasping forceps, teeth fine grooved, fenestrated, single action jaws HUNTER Darmfasszange, Zahnung fein gerieft, gefenstert, einfachbeweglich |
| <p>1/1 16 mm</p> | 223 | 300-223-2505 (25 cm) 300-223-3305 (33 cm) 300-223-3605 (36 cm) 300-223-4505 (45 cm) | Grasping forceps "Dolphin" with reservoir, double action jaws Fasszange „Delphin“ mit Reservoir, doppelbeweglich |
| <p>1/1 17,5 mm</p> | 224 | 300-224-2505 (25 cm) 300-224-3305 (33 cm) 300-224-3605 (36 cm) 300-224-4505 (45 cm) | Grasping forceps "Dolphin", double action jaws Fasszange „Delphin“, doppelbeweglich |
| <p>1/1 26 mm</p> | 225 | 300-225-2505 (25 cm) 300-225-3305 (33 cm) 300-225-3605 (36 cm) 300-225-4505 (45 cm) | Long Grasping forceps "Dolphin" with reservoir, double action jaws Lange Fasszange „Delphin“ mit Reservoir, doppelbeweglich |
| <p>1/1 13,5 mm</p> | 235 | 300-235-2505 (25 cm) 300-235-3305 (33 cm) 300-235-3605 (36 cm) 300-235-4505 (45 cm) | Short grasping forceps "Dolphin", double action jaws Kurze Fasszange „Delphin“, doppelbeweglich |



FORCEPS Ø 5 mm



GREIFER Ø 5 mm

| | Art No. for Set Art.-Nr. für Set | Art No. for single part Art.-Nr. für Einzelteil | Description Beschreibung |
|---|---|--|---|
|  <p>¼</p> <p>↔ 15 mm</p> | 226 | 300-226-2505 (25 cm) 300-226-3305 (33 cm) 300-226-3605 (36 cm) 300-226-4505 (45 cm) | Grasping forceps, smooth jaw shape, double action jaws Fasszange, glatte Maulform, doppelbeweglich |
|  <p>¼</p> <p>↔ 11 mm</p> | 231 | 300-231-2505 (25 cm) 300-231-3305 (33 cm) 300-231-3605 (36 cm) 300-231-4505 (45 cm) | Grasping forceps distal with row of teeth, single action jaws Fasszange distal mit Zahnreihe, einfachbeweglich |
|  <p>¼</p> <p>↔ 11,5 mm</p> | 232 | 300-232-2505 (25 cm) 300-232-3305 (33 cm) 300-232-3605 (36 cm) 300-232-4505 (45 cm) | Grasping forceps distal with row of teeth, double action jaws Fasszange distal mit Zahnreihe, doppelbeweglich |
|  <p>¼</p> <p>↔ 20 mm</p> | 234 | 300-234-2505 (25 cm) 300-234-3305 (33 cm) 300-234-3605 (36 cm) 300-234-4505 (45 cm) | BABCOCK Grasping forceps, fenestrated, double action jaws BABCOCK Fasszange, gefenstert, doppelbeweglich |
|  <p>¼</p> <p>↔ 21 mm</p> | 269 | 300-269-2505 (25 cm) 300-269-3305 (33 cm) 300-269-3605 (36 cm) 300-269-4505 (45 cm) | BABCOCK "Strong Hold" grasping forceps, fenestrated, double action jaws BABCOCK „Strong Hold“ Fasszange, gefenstert, doppelbeweglich |



FORCEPS Ø 5 mm

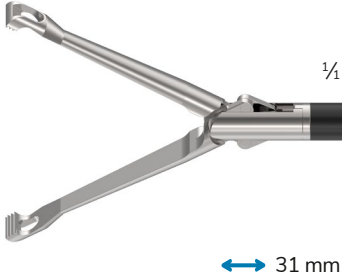
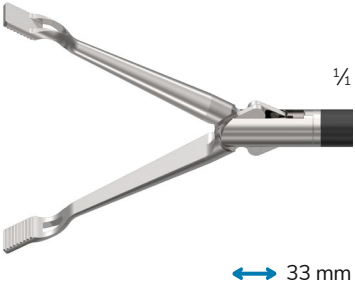
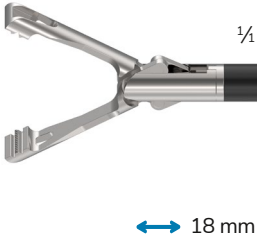
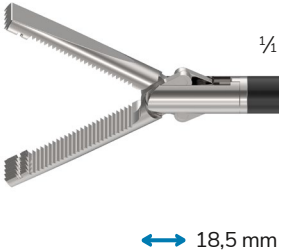



GREIFER Ø 5 mm

| | Art No. for Set Art.-Nr. für Set | Art No. for single part Art.-Nr. für Einzelteil | Description Beschreibung |
|---|-------------------------------------|--|--|
|  | 270 | 300-270-2505 (25 cm) 300-270-3305 (33 cm) 300-270-3605 (36 cm) 300-270-4505 (45 cm) | BABCOCK clamp, fenestrated, double action jaws BABCOCK-Klemme, gefenstert, doppelbeweglich |
|  | 271 | 300-271-2505 (25 cm) 300-271-3305 (33 cm) 300-271-3605 (36 cm) 300-271-4505 (45 cm) | BABCOCK grasping forceps, "Paddle", double action jaws BABCOCK Fasszange, „Paddel“, doppelbeweglich |
|  | 273 | 300-273-2505 (25 cm) 300-273-3305 (33 cm) 300-273-3605 (36 cm) 300-273-4505 (45 cm) | SWANSTRÖM grasping forceps, fenestrated, double action jaws SWANSTRÖM Fasszange, gefenstert, doppelbeweglich |
|  | 290 | 300-290-2505 (25 cm) 300-290-3305 (33 cm) 300-290-3605 (36 cm) 300-290-4505 (45 cm) | Long ALLIS atraumatic grasping forceps, double action jaws Lange ALLIS atraumatische Fasszange, doppelbeweglich |
|  | 291 | 300-291-2505 (25 cm) 300-291-3305 (33 cm) 300-291-3605 (36 cm) 300-291-4505 (45 cm) | ALLIS atraumatic grasping forceps, double action jaws ALLIS atraumatische Fasszange, doppelbeweglich |

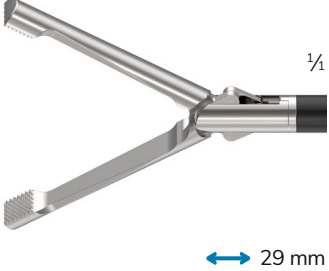

FORCEPS Ø 5 mm

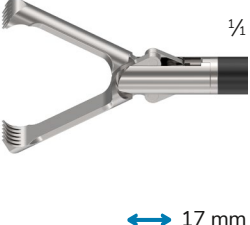



GREIFER Ø 5 mm

| | Art No. for Set Art.-Nr. für Set | Art No. for single part Art.-Nr. für Einzelteil | Description Beschreibung |
|---|-------------------------------------|--|---|
|  | 238 | 300-238-2505 (25 cm) 300-238-3305 (33 cm) 300-238-3605 (36 cm) 300-238-4505 (45 cm) | Grasping forceps with fine crosswise teeth, double action jaws Fasszange mit feiner Kreuzverzahnung, doppelbeweglich |
|  | 244 | 300-244-2505 (25 cm) 300-244-3305 (33 cm) 300-244-3605 (36 cm) 300-244-4505 (45 cm) | Grasping forceps with DeBAKEY-teeth, double action jaws Fasszange mit DeBAKEY-Zahnung, doppelbeweglich |
|  | 227 | 300-227-2505 (25 cm) 300-227-3305 (33 cm) 300-227-3605 (36 cm) 300-227-4505 (45 cm) | Micro claw forceps with teeth, double action jaws Mikro-Krallengreifzange mit Zähnen, doppelbeweglich |
|  | 242 | 300-242-2505 (25 cm) 300-242-3305 (33 cm) 300-242-3605 (36 cm) 300-242-4505 (45 cm) | Claw grasping forceps 3+2 teeth, single action jaws Krallengreifzange 3+2 Zähne, einfachbeweglich |
|  | 243 | 300-243-2505 (25 cm) 300-243-3305 (33 cm) 300-243-3605 (36 cm) 300-243-4505 (45 cm) | Claw grasping forceps aggressive, double action jaws Krallengreifzange aggressiv, doppelbeweglich |



FORCEPS Ø 5 mm

GREIFER Ø 5 mm

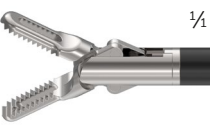
| | Art No. for Set Art.-Nr. für Set | Art No. for single part Art.-Nr. für Einzelteil | Description Beschreibung |
|---|---|--|---|
|  <p>1/2</p> <p>↔ 14 mm</p> | 228 | 300-228-2505 (25 cm) 300-228-3305 (33 cm) 300-228-3605 (36 cm) 300-228-4505 (45 cm) | Short grasping forceps sharp, crosswise teeth, double action jaws Kurze Fassungzange spitz, kreuzverzahnt, doppelbeweglich |
|  <p>1/2</p> <p>↔ 18 mm</p> | 230 | 300-230-2505 (25 cm) 300-230-3305 (33 cm) 300-230-3605 (36 cm) 300-230-4505 (45 cm) | Long grasping forceps sharp, crosswise teeth, double action jaws Lange Fassungzange spitz, kreuzverzahnt, doppelbeweglich |
|  <p>1/2</p> <p>↔ 18 mm</p> | 272 | 300-272-2505 (25 cm) 300-272-3305 (33 cm) 300-272-3605 (36 cm) 300-272-4505 (45 cm) | Grasping forceps sharp, crosswise teeth, single action jaws Fassungzange spitz, kreuzverzahnt, einfachbeweglich |
|  <p>1/2</p> <p>↔ 16,5 mm</p> | 229 | 300-229-2505 (25 cm) 300-229-3305 (33 cm) 300-229-3605 (36 cm) 300-229-4505 (45 cm) | Micro grasping forceps Ø 3 mm to Ø 5 mm, straight, single action jaws Mikro-Fassungzange Ø 3 mm auf Ø 5 mm, gerade, einfachbeweglich |
|  <p>1/2</p> <p>↔ 12 mm</p> | 298 | 300-298-2505 (25 cm) 300-298-3305 (33 cm) 300-298-3605 (36 cm) 300-298-4505 (45 cm) | Micro Dissecting forceps, fenestrated, double action jaws Mikro-Sezierzange, gefenestert, doppelbeweglich |



FORCEPS Ø 5 mm





GREIFER Ø 5 mm

| | Art No. for Set Art.-Nr. für Set | Art No. for single part Art.-Nr. für Einzelteil | Description Beschreibung |
|--------------------------------|---|--|---|
| <p>¼ 237 ↔ 25 mm</p> | | 300-237-2505 (25 cm) 300-237-3305 (33 cm) 300-237-3605 (36 cm) 300-237-4505 (45 cm) | Grasping forceps with double teeth, double action jaws Fasszange mit Doppelzahnung, doppelbeweglich |
| <p>¼ 240 ↔ 13,5 mm</p> | | 300-240-2505 (25 cm) 300-240-3305 (33 cm) 300-240-3605 (36 cm) 300-240-4505 (45 cm) | Grasping forceps with mouse teeth, double action jaws Fasszange mit Mauszahn, doppelbeweglich |
| <p>¼ 241 ↔ 13,5 mm</p> | | 300-241-2505 (25 cm) 300-241-3305 (33 cm) 300-241-3605 (36 cm) 300-241-4505 (45 cm) | Grasping forceps with mouse teeth, single action jaws Fasszange mit Mauszahn, einfachbeweglich |
| <p>¼ 245 ↔ 23 mm</p> | | 300-245-2505 (25 cm) 300-245-3305 (33 cm) 300-245-3605 (36 cm) 300-245-4505 (45 cm) | Grasping forceps with rough tooth pitch, fenestrated, double action jaws Fasszange mit grober Zahnteilung, gefenstert, doppelbeweglich |
| <p>¼ 246 ↔ 13,5 mm</p> | | 300-246-2505 (25 cm) 300-246-3305 (33 cm) 300-246-3605 (36 cm) 300-246-4505 (45 cm) | Extracting forceps with a retrograde row of teeth, double action jaws Extraktionszange mit retrograder Zahnreihe, doppelbeweglich |



FORCEPS Ø 5 mm

GREIFER Ø 5 mm

| | Art No. for Set Art.-Nr. für Set | Art No. for single part Art.-Nr. für Einzelteil | Description Beschreibung |
|--|-------------------------------------|--|--|
|  <p>↔ 11 mm</p> | 247 | 300-247-2505 (25 cm) 300-247-3305 (33 cm) 300-247-3605 (36 cm) 300-247-4505 (45 cm) | Extraction forceps, single action jaws Extraktionszange, einfachbeweglich |
|  <p>↔ 21,5 mm</p> | 250 | 300-250-2505 (25 cm) 300-250-3305 (33 cm) 300-250-3605 (36 cm) 300-250-4505 (45 cm) | Atraumatic grasper with wavy teeth and reservoir, single action jaws Atraumatischer Greifer mit gewellter Zahnung und Reservoir, einfachbeweglich |
|  <p>↔ 26,5 mm</p> | 251 | 300-251-2505 (25 cm) 300-251-3305 (33 cm) 300-251-3605 (36 cm) 300-251-4505 (45 cm) | Atraumatic grasper with wavy teeth and reservoir, double action jaws Atraumatischer Greifer mit gewellter Zahnung und Reservoir, doppelbeweglich |
|  <p>↔ 22 mm</p> | 252 | 300-252-2505 (25 cm) 300-252-3305 (33 cm) 300-252-3605 (36 cm) 300-252-4505 (45 cm) | Retraction grasper, single action jaws Greifer zur Retraktion, einfachbeweglich |
|  <p>↔ 22 mm</p> | 253 | 300-253-2505 (25 cm) 300-253-3305 (33 cm) 300-253-3605 (36 cm) 300-253-4505 (45 cm) | Retraction grasper, double action jaws Greifer zur Retraktion, doppelbeweglich |



FORCEPS Ø 5 mm



GREIFER Ø 5 mm

| | Art No. for Set Art.-Nr. für Set | Art No. for single part Art.-Nr. für Einzelteil | Description Beschreibung |
|----------------------|-------------------------------------|--|---|
| <p>¼ ↔ 40 mm</p> | 257 | 300-257-2505 (25 cm) 300-257-3305 (33 cm) 300-257-3605 (36 cm) 300-257-4505 (45 cm) | Long DeBAKEY forceps straight, fenestrated, double action jaws Lange DeBAKEY Fasszange gerade, gefenstert, doppelbeweglich |
| <p>¼ ↔ 28 mm</p> | 264 | 300-264-2505 (25 cm) 300-264-3305 (33 cm) 300-264-3605 (36 cm) 300-264-4505 (45 cm) | Short DeBAKEY clamp, double action jaws Kurze DeBAKEY-Klemme, doppelbeweglich |
| <p>¼ ↔ 45 mm</p> | 265 | 300-265-2505 (25 cm) 300-265-3305 (33 cm) 300-265-3605 (36 cm) 300-265-4505 (45 cm) | Long DeBAKEY clamp, double action jaws Lange DeBAKEY-Klemme, doppelbeweglich |
| <p>¼ ↔ 55 mm</p> | 283 | 300-283-2505 (25 cm) 300-283-3305 (33 cm) 300-283-3605 (36 cm) 300-283-4505 (45 cm) | DeBAKEY forceps, straight, double action jaws DeBAKEY Fasszange, gerade, doppelbeweglich |
| <p>¼ ↔ 20 mm</p> | 258 | 300-258-2505 (25 cm) 300-258-3305 (33 cm) 300-258-3605 (36 cm) 300-258-4505 (45 cm) | MIXTER grasping forceps, 90° angled, double action jaws MIXTER Fasszange, 90° gewinkelt, doppelbeweglich |

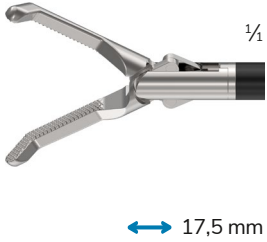
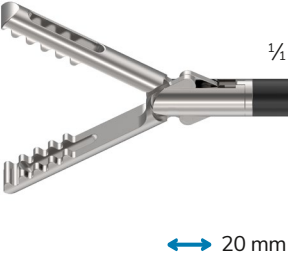
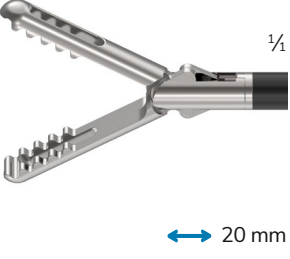
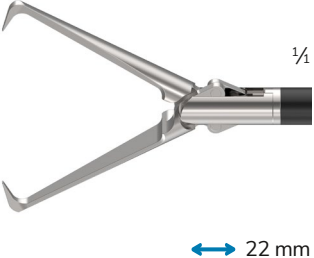

FORCEPS Ø 5 mm

GREIFER Ø 5 mm

| | Art No. for Set Art.-Nr. für Set | Art No. for single part Art.-Nr. für Einzelteil | Description Beschreibung |
|---|-------------------------------------|--|--|
|  | 259 | 300-259-2505 (25 cm) 300-259-3305 (33 cm) 300-259-3605 (36 cm) 300-259-4505 (45 cm) | MIXTER grasping forceps, 45° angled, double action jaws MIXTER Fasszange, 45° gewinkelt, doppelbeweglich |
|  | 274 | 300-274-2505 (25 cm) 300-274-3305 (33 cm) 300-274-3605 (36 cm) 300-274-4505 (45 cm) | SCHERTL grasping forceps, fenestrated, double action jaws SCHERTL Fasszange, gefenstert, doppelbeweglich |
|  | 275 | 300-275-2505 (25 cm) 300-275-3305 (33 cm) 300-275-3605 (36 cm) 300-275-4505 (45 cm) | SCHERTL Grasping forceps, rounded, fenestrated, double action jaws SCHERTL Fasszange, abgerundet, gefenstert, doppelbeweglich |
|  | 284 | 300-284-2505 (25 cm) 300-284-3305 (33 cm) 300-284-3605 (36 cm) 300-284-4505 (45 cm) | Tenaculum grasping forceps, double action jaws Tenaculum Fasszange, doppelbeweglich |
|  | 285 | 300-285-2505 (25 cm) 300-285-3305 (33 cm) 300-285-3605 (36 cm) 300-285-4505 (45 cm) | Tenaculum grasping forceps, double action jaws Tenaculum Fasszange, doppelbeweglich |



FORCEPS Ø 5 mm

GREIFER Ø 5 mm

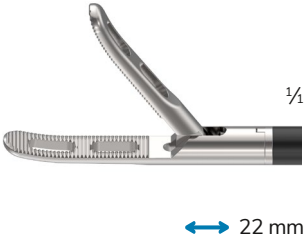
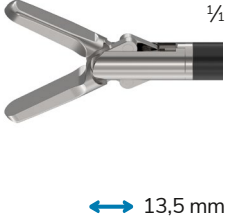
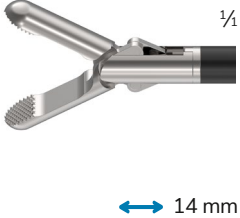
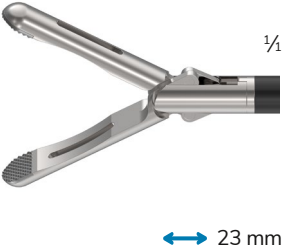
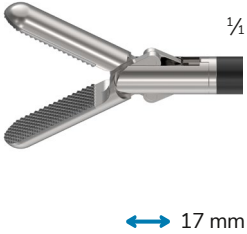
| | Art No. for Set Art.-Nr. für Set | Art No. for single part Art.-Nr. für Einzelteil | Description Beschreibung |
|---|-------------------------------------|--|--|
|  <p>1/1 ↔ 22 mm</p> | 292 | 300-292-2505 (25 cm) 300-292-3305 (33 cm) 300-292-3605 (36 cm) 300-292-4505 (45 cm) | OLMI grasping forceps, fenestrated, single action jaws OLMI Fasszange, gefenestert, einfachbeweglich |
|  <p>1/1 ↔ 13,5 mm</p> | 293 | 300-293-2505 (25 cm) 300-293-3305 (33 cm) 300-293-3605 (36 cm) 300-293-4505 (45 cm) | REDDICK-OLSEN grasping forceps without toothing, double action jaws REDDICK-OLSEN Fasszange ohne Zahnung, doppelbeweglich |
|  <p>1/1 ↔ 14 mm</p> | 279 | 300-279-2505 (25 cm) 300-279-3305 (33 cm) 300-279-3605 (36 cm) 300-279-4505 (45 cm) | Grasping forceps with fine crosswise teeth, rounded, double action jaws Fasszange mit feiner Kreuzverzahnung, abgerundet, doppelbeweglich |
|  <p>1/1 ↔ 23 mm</p> | 355 | 300-355-2505 (25 cm) 300-355-3305 (33 cm) 300-355-3605 (36 cm) 300-355-4505 (45 cm) | Grasping forceps with TC insert, fenestrated, double action jaws Fasszange mit Hartmetalleinlagen, gefenestert, doppelbeweglich |
|  <p>1/1 ↔ 17 mm</p> | 357 | 300-357-2505 (25 cm) 300-357-3305 (33 cm) 300-357-3605 (36 cm) 300-357-4505 (45 cm) | Strong grasping forceps with TC insert, fine, double action jaws Starke Fasszange mit Hartmetalleinlagen, fein, doppelbeweglich |



FORCEPS Ø 5 mm

GREIFER Ø 5 mm

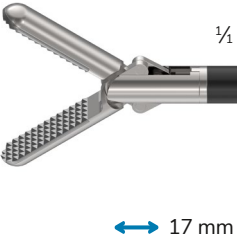
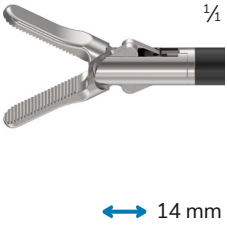
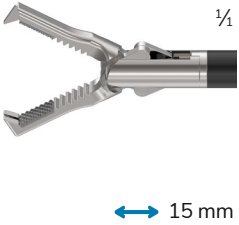
| | Art No. for Set Art.-Nr. für Set | Art No. for single part Art.-Nr. für Einzelteil | Description Beschreibung |
|--|-------------------------------------|--|---|
|  <p>1/4 ↔ 17 mm</p> | 297 | 300-297-2505 (25 cm) 300-297-3305 (33 cm) 300-297-3605 (36 cm) 300-297-4505 (45 cm) | Strong TC grasping forceps, rough, double action jaws Starke TC-Fasszange, grob, doppelbeweglich |
|  <p>1/4 ↔ 14 mm</p> | 299 | 300-299-2505 (25 cm) 300-299-3305 (33 cm) 300-299-3605 (36 cm) 300-299-4505 (45 cm) | Dissecting forceps, flat, tapered, double action jaws Sezier-Zange, flach, verjüngt, doppelbeweglich |
|  <p>1/4 ↔ 15 mm</p> | 351 | 300-351-2505 (25 cm) 300-351-3305 (33 cm) 300-351-3605 (36 cm) 300-351-4505 (45 cm) | Grasping forceps with 1 x 2 teeth, double action jaws Fasszange mit 1 x 2 Zähne, doppelbeweglich |



BIOPSY CUPS

BIOPSIE-LÖFFEL

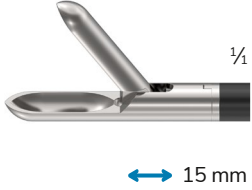
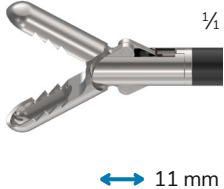
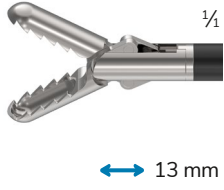
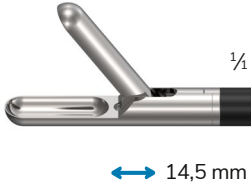
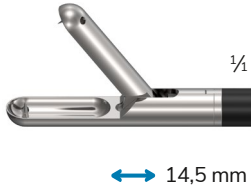
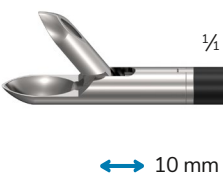
| | Art No. for Set Art.-Nr. für Set | Art No. for single part Art.-Nr. für Einzelteil | Description Beschreibung |
|---|---|--|---|
|  | 268 | 300-268-2505 (25 cm) 300-268-3305 (33 cm) 300-268-3605 (36 cm) 300-268-4505 (45 cm) | Tumor cup forceps, single action jaws Tumor Löffelzange, einfachbeweglich |
|  | 314 | 300-314-2505 (25 cm) 300-314-3305 (33 cm) 300-314-3605 (36 cm) 300-314-4505 (45 cm) | Cup forceps "Alligator", double action jaws Löffelzange „Alligator“, doppelbeweglich |
|  | 315 | 300-315-2505 (25 cm) 300-315-3305 (33 cm) 300-315-3605 (36 cm) 300-315-4505 (45 cm) | Cup forceps, double action jaws Löffelzange, doppelbeweglich |
|  | 316 | 300-316-2505 (25 cm) 300-316-3305 (33 cm) 300-316-3605 (36 cm) 300-316-4505 (45 cm) | Large cup, single action jaws Langer Löffel, einfachbeweglich |
|  | 318 | 300-318-2505 (25 cm) 300-318-3305 (33 cm) 300-318-3605 (36 cm) 300-318-4505 (45 cm) | Large cup with thorn, single action jaws Langer Löffel mit Dorn, einfachbeweglich |
|  | 320 | 300-320-2505 (25 cm) 300-320-3305 (33 cm) 300-320-3605 (36 cm) 300-320-4505 (45 cm) | Cup forceps, sharp, fenestrated, single action jaws Löffelzange, spitz, gefenstert, einfachbeweglich |



BIOPSY CUPS

BIOPSIE-LÖFFEL

| | Art No. for Set Art.-Nr. für Set | Art No. for single part Art.-Nr. für Einzelteil | Description Beschreibung |
|--|-------------------------------------|--|---|
| | 310 | 300-310-2505 (25 cm) 300-310-3305 (33 cm) 300-310-3605 (36 cm) 300-310-4505 (45 cm) | Biopsy cup, double action jaws Biopsie-Löffel, doppelbeweglich |
| | 312 | 300-312-2505 (25 cm) 300-312-3305 (33 cm) 300-312-3605 (36 cm) 300-312-4505 (45 cm) | Biopsy cup with thorn, double action jaws Biopsie-Löffel mit Dorn, doppelbeweglich |

BIOPSY PUNCHES

BIOPSIE-STANZEN

| | Art No. for Set Art.-Nr. für Set | Art No. for single part Art.-Nr. für Einzelteil | Description Beschreibung |
|--|-------------------------------------|--|--|
| | 410 | 300-410-2505 (25 cm) 300-410-3305 (33 cm) 300-410-3605 (36 cm) 300-410-4505 (45 cm) | Biopsy punch, single action jaws Biopsie-Stanze, einfachbeweglich |
| | 412 | 300-412-2505 (25 cm) 300-412-3305 (33 cm) 300-412-3605 (36 cm) 300-412-4505 (45 cm) | Biopsy punch with thorn, single action jaws Biopsie-Stanze mit Dorn, einfachbeweglich |
| | 414 | 300-414-2505 (25 cm) 300-414-3305 (33 cm) 300-414-3605 (36 cm) 300-414-4505 (45 cm) | Biopsy punch with hook, single action jaws Biopsie-Stanze mit Haken, einfachbeweglich |



NEEDLE HOLDERS Ø 5 mm

NADELHALTER Ø 5 mm

| | Art No. for Set Art.-Nr. für Set | Art No. for single part Art.-Nr. für Einzelteil | Description Beschreibung |
|--|-------------------------------------|--|---|
| | 350 | 300-350-2505 (25 cm) 300-350-3305 (33 cm) 300-350-3605 (36 cm) 300-350-4505 (45 cm) | Straight with TC insert, crosswise teeth, single action jaws Gerade mit Hartmetalleinlagen, kreuzverzahnt, einfachbeweglich |
| | 352 | 300-352-2505 (25 cm) 300-352-3305 (33 cm) 300-352-3605 (36 cm) 300-352-4505 (45 cm) | Left curved with TC insert, crosswise teeth, single action jaws Links gebogen mit Hartmetalleinlagen, kreuzverzahnt, einfachbeweglich |
| | 354 | 300-354-2505 (25 cm) 300-354-3305 (33 cm) 300-354-3605 (36 cm) 300-354-4505 (45 cm) | Right curved with TC insert, crosswise teeth, single action jaws Rechts gebogen mit Hartmetalleinlagen, kreuzverzahnt, einfachbeweglich |
| | 360 | 300-360-2505 (25 cm) 300-360-3305 (33 cm) 300-360-3605 (36 cm) 300-360-4505 (45 cm) | Needle holder/-positioner, convex/concave shaped jaws with fixation teeth, with wolfram-carbide-coated tips, single action jaws Nadelhalter -positionierer, konvex/konvav geformte Maulform mit Fixierzähnen, Greifflächen mit Wolfram-Karbid-Beschichtung, einfachbeweglich |

LAPAROSCOPY INSTRUMENTS Ø 10 mm

LAPAROSKOPIE-INSTRUMENTE Ø 10 mm



3-part system (modular)

With or without flushing connection

Available in three working lengths

Can be ordered as single parts or as a set

3-teiliges System (modular)

Mit oder ohne Spülanschluss

In drei Arbeitslängen erhältlich

Bestellbar als einzelne Teile oder als Set



TUBE SHAFTS Ø 10 mm

ROHRSCHÄFTE Ø 10 mm

| Working Length Arbeitslänge | Art No. for single part Art.-Nr. für Einzelteil | Description Beschreibung |
|--------------------------------|--|---|
| 33 cm | 300-100-3310 | |
| 36 cm | 300-100-3610 | without flushing connection ohne Spülanschluss |
| 45 cm | 300-100-4510 | |
| 33 cm | 300-100-3310L | |
| 36 cm | 300-100-3610L | with flushing connection mit Spülanschluss |
| 45 cm | 300-100-4510L | |



| without flushing connection
 | ohne Spülanschluss



| with flushing connection
 | mit Spülanschluss

To order sets and perform assembly/disassembly, the same principle applies as for the modular 5 mm system.

See page 19 - 22.

Um Sets zu bestellen und die Montage/Demontage durchzuführen gilt das selbe Prinzip wie beim modularen 5 mm System.

Siehe Seite 19 - 22.



FORCEPS Ø 10 mm







GREIFER Ø 10 mm

| | Art No. for Set Art.-Nr. für Set | Art No. for single part Art.-Nr. für Einzelteil | Description Beschreibung |
|---|-------------------------------------|--|--|
|  | 610 | 300-610-3310 (33 cm) 300-610-3610 (36 cm) 300-610-4510 (45 cm) | Claw grasping and extracting forceps, 2+3 teeth, single action jaws Krallengreifzange, 2+3 Zähne, einfachbeweglich |
|  | 611 | 300-611-3310 (33 cm) 300-611-3610 (36 cm) 300-611-4510 (45 cm) | Claw grasping and extracting forceps, 2+3 teeth, double action jaws Krallengreifzange, 2+3 Zähne, doppelbeweglich |
|  | 612 | 300-612-3310 (33 cm) 300-612-3610 (36 cm) 300-612-4510 (45 cm) | MARYLAND grasping forceps, double action jaws MARYLAND Fasszange, doppelbeweglich |
|  | 614 | 300-614-3310 (33 cm) 300-614-3610 (36 cm) 300-614-4510 (45 cm) | Grasping forceps with DeBAKEY teeth, fenestrated, double action jaws Fasszange mit DeBAKEY Zahnung, gefenstert, doppelbeweglich |
|  | 616 | 300-616-3310 (33 cm) 300-616-3610 (36 cm) 300-616-4510 (45 cm) | BABCOCK grasping forceps, fenestrated, double action jaws BABCOCK grasping forceps, gefenstert, doppelbeweglich |
|  | 642 | 300-642-3310 (33 cm) 300-642-3610 (36 cm) 300-642-4510 (45 cm) | BABCOCK grasping forceps, with crosswise teeth, double action jaws BABCOCK Fasszange, mit Kreuzverzahnung, doppelbeweglich |



FORCEPS AND CLAMPS Ø 10 mm

GREIFER UND KLEMMEN Ø 10 mm

| | Art No. for Set Art.-Nr. für Set | Art No. for single part Art.-Nr. für Einzelteil | Description Beschreibung |
|---|---|--|--|
|  | 646 | 300-646-3310 (33 cm) 300-646-3610 (36 cm) 300-646-4510 (45 cm) | MIXTER grasping forceps, double action jaws MIXTER Fasszange, doppelbeweglich |
|  | | 300-622-3310 (33 cm) 300-622-3610 (36 cm) 300-622-4510 (45 cm) | 622 KOCHER clamp, jaw length 30 mm , double action jaws KOCHER Klemme, Maullänge 30 mm , doppelbeweglich |
|  | | 300-623-3310 (33 cm) 300-623-3610 (36 cm) 300-623-4510 (45 cm) | 623 KOCHER clamp, jaw length 40 mm , double action jaws KOCHER Klemme, Maullänge 40 mm , doppelbeweglich |
|  | | 300-624-3310 (33 cm) 300-624-3610 (36 cm) 300-624-4510 (45 cm) | 624 KOCHER clamp, jaw length 50 mm , double action jaws KOCHER Klemme, Maullänge 50 mm , doppelbeweglich |
|  | | 300-631-3310 (33 cm) 300-631-3610 (36 cm) 300-631-4510 (45 cm) | 631 DeBAKEY clamp, double teeth, jaw length 30 mm , double action jaws DeBAKEY Klemme, doppelte Zahnreihe, Maullänge 30 mm , doppelbeweglich |
|  | | 300-632-3310 (33 cm) 300-632-3610 (36 cm) 300-632-4510 (45 cm) | 632 DeBAKEY clamp, double teeth, jaw length 40 mm , double action jaws DeBAKEY Klemme, doppelte Zahnreihe, Maullänge 40 mm , doppelbeweglich |
|  | | 300-633-3310 (33 cm) 300-633-3610 (36 cm) 300-633-4510 (45 cm) | 633 DeBAKEY clamp, double teeth, jaw length 50 mm , double action jaws DeBAKEY Klemme, doppelte Zahnreihe, Maullänge 50 mm , doppelbeweglich |



FORCEPS AND CLAMPS Ø 10 mm



GREIFER UND KLEMMEN Ø 10 mm

| | Art No. for Set Art.-Nr. für Set | Art No. for single part Art.-Nr. für Einzelteil | Description Beschreibung |
|---|-------------------------------------|--|--|
|  | 656 | 300-656-3310 (33 cm) 300-656-3610 (36 cm) 300-656-4510 (45 cm) | <ul style="list-style-type: none"> Tenaculum forceps, double action jaws Tenaculum Fasszange, doppelbeweglich |
|  | 654 | 300-654-3310 (33 cm) 300-654-3610 (36 cm) 300-654-4510 (45 cm) | <ul style="list-style-type: none"> OVERHOLT clamp with fine teeth, curved, double action jaws OVERHOLT Klemme mit feiner Zahnung, gebogen, doppelbeweglich |
|  | 648 | 300-648-3310 (33 cm) 300-648-3610 (36 cm) 300-648-4510 (45 cm) | <ul style="list-style-type: none"> DORSEY grasping forceps, fenestrated double action jaws DORSEY Fasszange, gefenestert, doppelbeweglich |
|  | 618 | 300-618-3310 (33 cm) 300-618-3610 (36 cm) 300-618-4510 (45 cm) | <ul style="list-style-type: none"> BABCOCK clamp, fenestrated, double action jaws BABCOCK Klemme, gefenestert, doppelbeweglich |
|  | 620 | 300-620-3310 (33 cm) 300-620-3610 (36 cm) 300-620-4510 (45 cm) | <ul style="list-style-type: none"> COLLIN clamp, fenestrated, double action jaws COLLIN Klemme, gefenestert, doppelbeweglich |
|  | 650 | 300-650-3310 (33 cm) 300-650-3610 (36 cm) 300-650-4510 (45 cm) | <ul style="list-style-type: none"> PENNINGTON clamp, fenestrated, double action jaws PENNINGTON Klemme, gefenestert, doppelbeweglich |



SCISSORS AND CUPS Ø 10 mm

SCHEREN UND LÖFFEL Ø 10 mm

| | Art No. for Set Art.-Nr. für Set | Art No. for single part Art.-Nr. für Einzelteil | Description Beschreibung |
|---|---|--|--|
|  | 710 | 300-710-3310 (33 cm) 300-710-3610 (36 cm) 300-710-4510 (45 cm) | Large OP scissors, single action jaws Große OP-Schere, einfachbeweglich |
|  | 810 | 300-810-3310 (33 cm) 300-810-3610 (36 cm) 300-810-4510 (45 cm) | Large cup, single action jaws Großer Löffel, einfachbeweglich |



INTEGRAL NEEDLE HOLDERS Ø 3 mm

INTEGRALE NADELHALTER Ø 3 mm



- | Axial ring handle with surgical ratchet and flushing connection.
- | Axialer Ringgriff mit chirurgischer Sperre und Spülanschluss.

| | Description Beschreibung | Working Length Arbeitslänge | Art No. Art.-Nr. |
|--|--|--------------------------------|---------------------|
| | Straight with TC insert, crosswise teeth, single action jaws | 33 cm | 301-350-0050 |
| | Gerade mit Hartmetalleinlagen, kreuzverzahnt, einfachbeweglich | 21 cm | 301-350-0150 |
| | Left curved with TC insert, crosswise teeth, single action jaws | 33 cm | 301-352-0050 |
| | Links gebogen mit Hartmetalleinlagen, kreuzverzahnt, einfachbeweglich | 21 cm | 301-352-0150 |
| | Right curved with TC insert, crosswise teeth, single action jaws | 33 cm | 301-354-0050 |
| | Rechts gebogen mit Hartmetalleinlagen, kreuzverzahnt, einfachbeweglich | 21 cm | 301-354-0150 |
| | Needle holder/-positioner, convex/concave shaped jaws with fixation teeth, with wolfram-carbide-coated tips, single action jaws | 33 cm | 301-360-0050 |
| | Nadelhalter -positionierer, konvex/konvav geformte Maulform mit Fixierzähnen, Greifflächen mit Wolfram-Karbid-Beschichtung, einfach- beweglich | 21 cm | 301-360-0150 |









INTEGRAL NEEDLE HOLDERS Ø 5 mm

INTEGRALE NADELHALTER Ø 5 mm

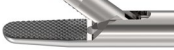

| Axial ring handle with surgical ratchet and flushing connection.

| Axialer Ringgriff mit chirurgischer Sperre und Spülanschluss.

| Description Beschreibung | Working Length Arbeitslänge | Art No. Art.-Nr. |
|--|--------------------------------|---------------------|
|  | 25 cm | 300-350-0150 |
| Straight with TC insert, crosswise teeth, single action jaws | 33 cm | 300-350-0350 |
|  | 36 cm | 300-350-0050 |
| Gerade mit Hartmetalleinlagen, kreuzverzahnt, einfachbeweglich | 45 cm | 300-350-0250 |
|  | 25 cm | 300-352-0150 |
| Left curved with TC insert, crosswise teeth, single action jaws | 33 cm | 300-352-0350 |
|  | 36 cm | 300-352-0050 |
| Links gebogen mit Hartmetalleinlagen, kreuzverzahnt, einfachbeweglich | 45 cm | 300-352-0250 |
|  | 25 cm | 300-354-0150 |
| Right curved with TC insert, crosswise teeth, single action jaws | 33 cm | 300-354-0350 |
|  | 36 cm | 300-354-0050 |
| Rechts gebogen mit Hartmetalleinlagen, kreuzverzahnt, einfachbeweglich | 45 cm | 300-354-0250 |
|  | 25 cm | 300-360-0150 |
| Needle holder/-positioner, convex/concave shaped jaws with fixation teeth, with wolfram-carbide-coated tips, single action jaws | 33 cm | 300-360-0350 |
|  | 36 cm | 300-360-0050 |
| Nadelhalter -positionierer, konvex/konvav geformte Maulform mit Fixierzähnen, Greifflächen mit Wolfram-Karbid-Beschichtung, einfach- beweglich | 45 cm | 300-360-0250 |





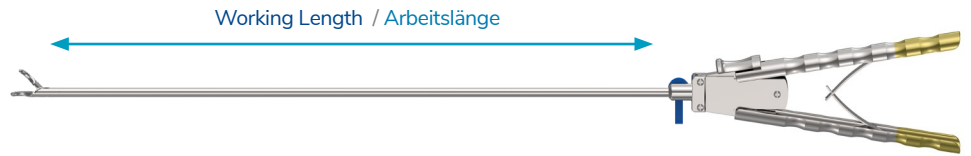

INTEGRAL NEEDLE HOLDERS Ø 3 mm

INTEGRALE NADELHALTER Ø 3 mm



- | Axial handle with ratchet, retaining spring and flushing connection.
- | Axialgriff mit Sperre, Rückstellfeder und Spülanschluss.

¼

| | Description Beschreibung | Working Length Arbeitslänge | Art No. Art.-Nr. |
|---|--|--------------------------------|---------------------|
|  | Straight with TC insert, crosswise teeth, single action jaws | 33 cm | 301-350-0060 |
| | Gerade mit Hartmetalleinlagen, kreuzverzahnt, einfachbeweglich | 21 cm | 301-350-0160 |
|  | Left curved with TC insert, crosswise teeth, single action jaws | 33 cm | 301-352-0060 |
| | Links gebogen mit Hartmetalleinlagen, kreuzverzahnt, einfachbeweglich | 21 cm | 301-352-0160 |
|  | Right curved with TC insert, crosswise teeth, single action jaws | 33 cm | 301-354-0060 |
| | Rechts gebogen mit Hartmetalleinlagen, kreuzverzahnt, einfachbeweglich | 21 cm | 301-354-0160 |
|  | Needle holder/-positioner, convex/concave shaped jaws with fixation teeth, with wolfram-carbide-coated tips, single action jaws | 33 cm | 301-360-0060 |
| | Nadelhalter -positionierer, konvex/konvav geformte Maulform mit Fixierzähnen, Greifflächen mit Wolfram-Karbid-Beschichtung, einfach- beweglich | 21 cm | 301-360-0160 |



INTEGRAL NEEDLE HOLDERS Ø 5 mm



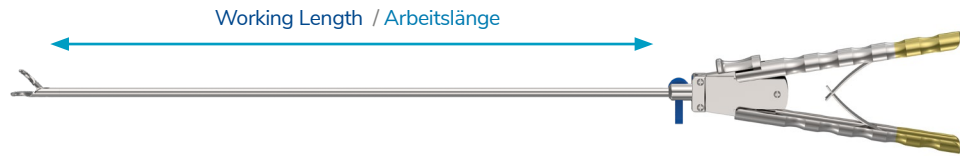

INTEGRALE NADELHALTER Ø 5 mm



| Axial handle with ratchet, retaining spring and flushing connection.

| Axialgriff mit Sperre, Rückstellfeder und Spülanschluss.

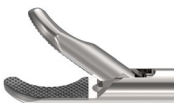
¼

| Description Beschreibung | Working Length Arbeitslänge | Art No. Art.-Nr. |
|---|--------------------------------|---------------------|
|  <p>Straight with TC insert, crosswise teeth, single action jaws Gerade mit Hartmetalleinlagen, kreuzverzahnt, einfachbeweglich</p> | 25 cm | 300-350-0160 |
| | 33 cm | 300-350-0360 |
| | 36 cm | 300-350-0060 |
| | 45 cm | 300-350-0260 |
|  <p>Left curved with TC insert, crosswise teeth, single action jaws Links gebogen mit Hartmetalleinlagen, kreuzverzahnt, einfachbeweglich</p> | 25 cm | 300-352-0160 |
| | 33 cm | 300-352-0360 |
| | 36 cm | 300-352-0060 |
|  <p>Right curved with TC insert, crosswise teeth, single action jaws Rechts gebogen mit Hartmetalleinlagen, kreuzverzahnt, einfachbeweglich</p> | 45 cm | 300-352-0260 |
| | 25 cm | 300-354-0160 |
| | 33 cm | 300-354-0360 |
|  <p>Needle holder/-positionier, convex/concave shaped jaws with fixation teeth, with wolfram-carbide-coated tips, single action jaws Nadelhalter -positionierer, konvex/konvav geformte Maulform mit Fixierzähnen, Greifflächen mit Wolfram-Karbid-Beschichtung, einfach- beweglich</p> | 36 cm | 300-354-0060 |
| | 45 cm | 300-354-0260 |
| | 25 cm | 300-360-0160 |
|  | 33 cm | 300-360-0360 |
| | 36 cm | 300-360-0060 |
| | 45 cm | 300-360-0260 |







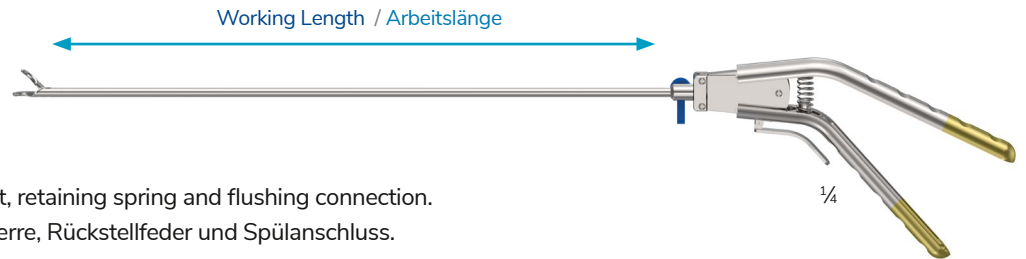

INTEGRAL NEEDLE HOLDERS Ø 3 mm

INTEGRALE NADELHALTER Ø 3 mm



| Angled axial handle with ratchet, retaining spring and flushing connection.

| Abgewinkelter Axialgriff mit Sperre, Rückstellfeder und Spülanschluss.

| | Description Beschreibung | Working Length Arbeitslänge | Art No. Art.-Nr. |
|---|--|--------------------------------|---------------------|
|  | Straight with TC insert, crosswise teeth, single action jaws | 33 cm | 301-350-0070 |
| | Gerade mit Hartmetalleinlagen, kreuzverzahnt, einfachbeweglich | 21 cm | 301-350-0170 |
|  | Left curved with TC insert, crosswise teeth, single action jaws | 33 cm | 301-352-0070 |
| | Links gebogen mit Hartmetalleinlagen, kreuzverzahnt, einfachbeweglich | 21 cm | 301-352-0170 |
|  | Right curved with TC insert, crosswise teeth, single action jaws | 33 cm | 301-354-0070 |
| | Rechts gebogen mit Hartmetalleinlagen, kreuzverzahnt, einfachbeweglich | 21 cm | 301-354-0170 |
|  | Needle holder/-positioner, convex/concave shaped jaws with fixation teeth, with wolfram-carbide-coated tips, single action jaws | 33 cm | 301-360-0070 |
| | Nadelhalter -positionierer, konvex/konvav geformte Maulform mit Fixierzähnen, Greifflächen mit Wolfram-Karbid-Beschichtung, einfach- beweglich | 21 cm | 301-360-0170 |





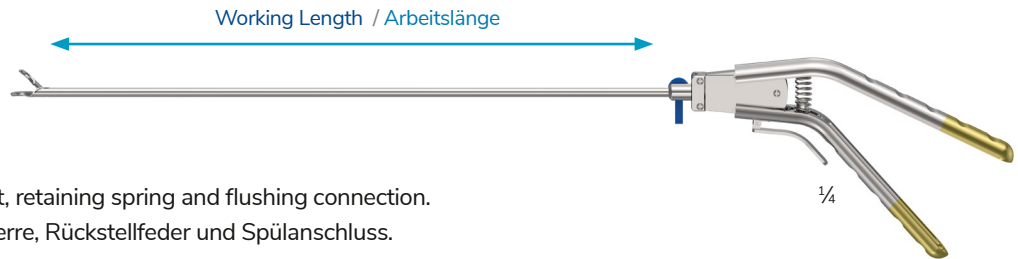

INTEGRAL NEEDLE HOLDERS Ø 5 mm

INTEGRALE NADELHALTER Ø 5 mm



| Angled axial handle with ratchet, retaining spring and flushing connection.
 | Abgewinkelter Axialgriff mit Sperre, Rückstellfeder und Spülanschluss.

| Description Beschreibung | Working Length Arbeitslänge | Art No. Art.-Nr. |
|---|--------------------------------|---------------------|
|  <p>Straight with TC insert, crosswise teeth, single action jaws Gerade mit Hartmetalleinlagen, kreuzverzahnt, einfachbeweglich</p> | 25 cm | 300-350-0170 |
| | 33 cm | 300-350-0370 |
| | 36 cm | 300-350-0070 |
| | 45 cm | 300-350-0270 |
|  <p>Left curved with TC insert, crosswise teeth, single action jaws Links gebogen mit Hartmetalleinlagen, kreuzverzahnt, einfachbeweglich</p> | 25 cm | 300-352-0170 |
| | 33 cm | 300-352-0370 |
| | 36 cm | 300-352-0070 |
| | 45 cm | 300-352-0270 |
|  <p>Right curved with TC insert, crosswise teeth, single action jaws Rechts gebogen mit Hartmetalleinlagen, kreuzverzahnt, einfachbeweglich</p> | 25 cm | 300-354-0170 |
| | 33 cm | 300-354-0370 |
| | 36 cm | 300-354-0070 |
| | 45 cm | 300-354-0270 |
|  <p>Needle holder/-positionier, convex/concave shaped jaws with fixation teeth, with wolfram-carbide-coated tips, single action jaws Nadelhalter -positionierer, konvex/konvav geformte Maulform mit Fixierzähnen, Greifflächen mit Wolfram-Karbid-Beschichtung, einfach- beweglich</p> | 25 cm | 300-360-0170 |
| | 33 cm | 300-360-0370 |
| | 36 cm | 300-360-0070 |
| | 45 cm | 300-360-0270 |





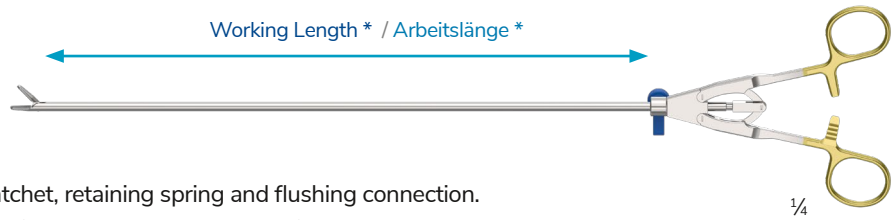

INTEGRAL NEEDLE HOLDERS Ø 5 mm

INTEGRALE NADELHALTER Ø 5 mm



| Axial ring handle with surgical ratchet, retaining spring and flushing connection.
 | Axialer Ringgriff mit chirurgischer Sperre, Rückstellfeder und Spülanschluss.

| *Other working lengths are available on request. | *Abweichende Arbeitslängen sind auf Anfrage möglich.

| | Description Beschreibung | Working Length Arbeitslänge | Art No. Art.-Nr. |
|---|---|--------------------------------|---------------------|
|  | Straight with TC insert, crosswise teeth, single action jaws | 35 cm | 300-954-0350 |
| | Gerade mit Hartmetalleinlagen, kreuzverzahnt, einfachbeweglich | 45 cm | 300-954-0450 |
|  | Left curved with TC insert, crosswise teeth, single action jaws | 35 cm | 300-955-0350 |
| | Links gebogen mit Hartmetalleinlagen, kreuzverzahnt, einfachbeweglich | 45 cm | 300-955-0450 |
|  | Right curved with TC insert, crosswise teeth, single action jaws | 35 cm | 300-956-0350 |
| | Rechts gebogen mit Hartmetalleinlagen, kreuzverzahnt, einfachbeweglich | 45 cm | 300-956-0450 |





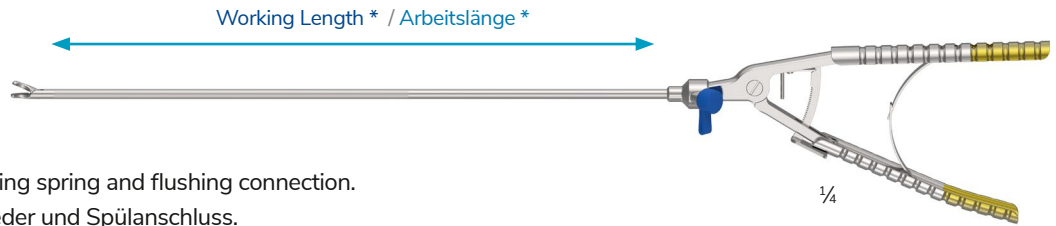

INTEGRAL NEEDLE HOLDERS Ø 5 mm

INTEGRALE NADELHALTER Ø 5 mm



| Axial handle with ratchet, retaining spring and flushing connection.
 | Axialgriff mit Sperre, Rückstellfeder und Spülanschluss.

| *Other working lengths are available on request. | *Abweichende Arbeitslängen sind auf Anfrage möglich.

| | Description Beschreibung | Working Length Arbeitslänge | Art No. Art.-Nr. |
|---|--|--------------------------------|---------------------|
|  | Straight with TC insert, crosswise teeth, single action jaws | 33 cm | 300-914-0330 |
| | Gerade mit Hartmetalleinlagen, kreuzverzahnt, einfachbeweglich | 45 cm | 300-914-0450 |
|  | Left curved with TC insert, crosswise teeth, single action jaws | 33 cm | 300-915-0330 |
| | Links gebogen mit Hartmetalleinlagen, kreuzverzahnt, einfachbeweglich | 45 cm | 300-915-0450 |
|  | Right curved with TC insert, crosswise teeth, single action jaws | 33 cm | 300-916-0330 |
| | Rechts gebogen mit Hartmetalleinlagen, kreuzverzahnt, einfachbeweglich | 45 cm | 300-916-0450 |
|  | Needle holder/-positioner, convex/concave shaped jaws with fixation teeth, with wolfram-carbide-coated tips, single action jaws | 33 cm | 300-918-0330 |
| | Nadelhalter -positionierer, konvex/konvav geformte Maulform mit Fixierzähnen, Greifflächen mit Wolfram-Karbid-Beschichtung, einfach- beweglich | 45 cm | 300-918-0450 |









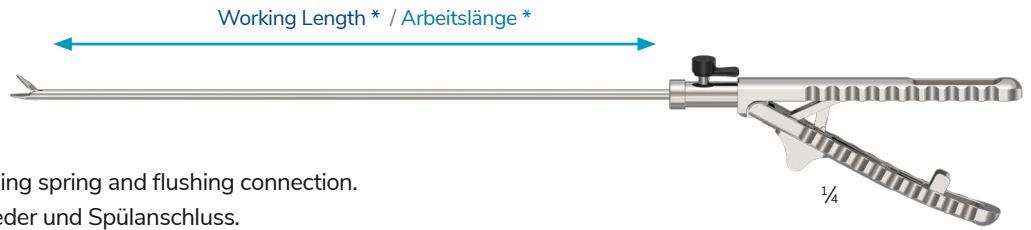

INTEGRAL NEEDLE HOLDERS Ø 3 and 5 mm

INTEGRALE NADELHALTER Ø 3 und 5 mm



| Axial handle with ratchet, retaining spring and flushing connection.
 | Axialgriff mit Sperre, Rückstellfeder und Spülanschluss.

| *Other working lengths are available on request. | *Abweichende Arbeitslängen sind auf Anfrage möglich.

| Ø 3 mm | Description Beschreibung | Working Length Arbeitslänge | Art No. Art.-Nr. |
|---|--|--------------------------------|------------------------------|
|  | Straight with TC insert, crosswise teeth, single action jaws Gerade mit Hartmetalleinlagen, kreuzverzahnt, einfachbeweglich | 25 cm 33 cm | 300-944-0250 300-944-0330 |
|  | Left curved with TC insert, crosswise teeth, single action jaws Links gebogen mit Hartmetalleinlagen, kreuzverzahnt, einfachbeweglich | 25 cm 33 cm | 300-945-0250 300-945-0330 |
|  | Right curved with TC insert, crosswise teeth, single action jaws Rechts gebogen mit Hartmetalleinlagen, kreuzverzahnt, einfachbeweglich | 25 cm 33 cm | 300-946-0250 300-946-0330 |
| Ø 5 mm | Description Beschreibung | Working Length Arbeitslänge | Art No. Art.-Nr. |
|  | Straight with TC insert, crosswise teeth, single action jaws Gerade mit Hartmetalleinlagen, kreuzverzahnt, einfachbeweglich | 33 cm 45 cm | 300-934-0330 300-934-0450 |
|  | Left curved with TC insert, crosswise teeth, single action jaws Links gebogen mit Hartmetalleinlagen, kreuzverzahnt, einfachbeweglich | 33 cm 45 cm | 300-935-0330 300-935-0450 |
|  | Right curved with TC insert, crosswise teeth, single action jaws Rechts gebogen mit Hartmetalleinlagen, kreuzverzahnt, einfachbeweglich | 33 cm 45 cm | 300-936-0330 300-936-0450 |
|  | Needle holder/-positioner, convex/concave shaped jaws with fixation teeth, with wolfram-carbide-coated tips, single action jaws Nadelhalter -positionierer, konvex/konvav geformte Maulform mit Fixierzähnen, Greifflächen mit Wolfram-Karbid-Beschichtung, einfach- beweglich | 33 cm 45 cm | 300-937-0330 300-937-0450 |



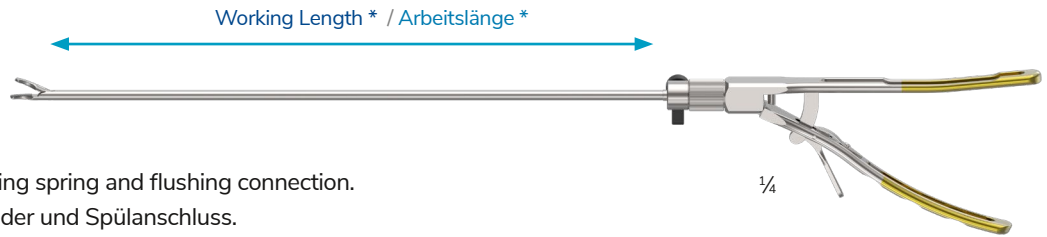

INTEGRAL NEEDLE HOLDERS Ø 5 mm

INTEGRALE NADELHALTER Ø 5 mm



| Axial handle with ratchet, retaining spring and flushing connection.
 | Axialgriff mit Sperre, Rückstellfeder und Spülanschluss.

| *Other working lengths are available on request. | *Abweichende Arbeitslängen sind auf Anfrage möglich.

| | Description Beschreibung | Working Length Arbeitslänge | Art No. Art.-Nr. |
|---|---|--------------------------------|---------------------|
|  | Straight with TC insert, crosswise teeth, single action jaws | 33 cm | 300-924-0330 |
| | Gerade mit Hartmetalleinlagen, kreuzverzahnt, einfachbeweglich | 45 cm | 300-924-0450 |
|  | Left curved with TC insert, crosswise teeth, single action jaws | 33 cm | 300-925-0330 |
| | Links gebogen mit Hartmetalleinlagen, kreuzverzahnt, einfachbeweglich | 45 cm | 300-925-0450 |
|  | Right curved with TC insert, crosswise teeth, single action jaws | 33 cm | 300-926-0330 |
| | Rechts gebogen mit Hartmetalleinlagen, kreuzverzahnt, einfachbeweglich | 45 cm | 300-926-0450 |



INTEGRAL SLIDE LOCK GRASPERS Ø 5 mm

INTEGRALE SLIDE LOCK GREIFZANGEN Ø 5 mm

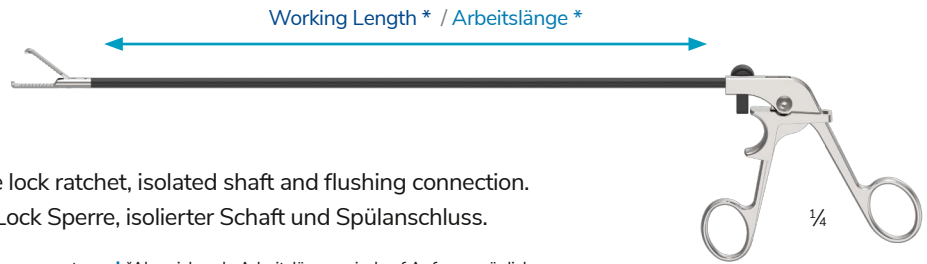



| Axial ring handle with slide lock ratchet, isolated shaft and flushing connection.
 | Axialer Ringgriff mit Slide Lock Sperre, isolierter Schaft und Spülanschluss.

| *Other working lengths are available on request. | *Abweichende Arbeitslängen sind auf Anfrage möglich.



Atraumatic Grasper

Atraumatische Greifzangen

| | Description Beschreibung | Working Length Arbeitslänge | Art No. Art.-Nr. |
|---|---|--------------------------------|---------------------|
|  | Atraumatic grasper, wavy teeth with Reservoir, single action jaws | 36 cm | PT250-36-01 |
| | Atraumatische Greifzange, gewellte Zahnung mit Reservoir, einfachbeweglich | 45 cm | PT250-45-01 |
|  | Atraumatic grasper, wavy teeth with Reservoir, double action jaws | 36 cm | PT251-36-01 |
| | Atraumatische Greifzange, gewellte Zahnung mit Reservoir, doppelbeweglich | 45 cm | PT251-45-01 |

Retraction Grasper

Retraktions-Greifzangen

| | Description Beschreibung | Working Length Arbeitslänge | Art No. Art.-Nr. |
|---|---|--------------------------------|---------------------|
|  | Retraction grasper, wavy teeth, single action jaws | 36 cm | PT252-36-01 |
| | Retraktions-Greifzange, gewellte Zahnung, einfachbeweglich | 45 cm | PT252-45-01 |
|  | Retraction grasper, wavy teeth, double action jaws | 36 cm | PT253-36-01 |
| | Retraktions-Greifzange, gewellte Zahnung, doppelbeweglich | 45 cm | PT253-45-01 |



INTEGRAL SLIDE LOCK GRASPERS Ø 5 mm

INTEGRALE SLIDE LOCK GREIFZANGEN Ø 5 mm

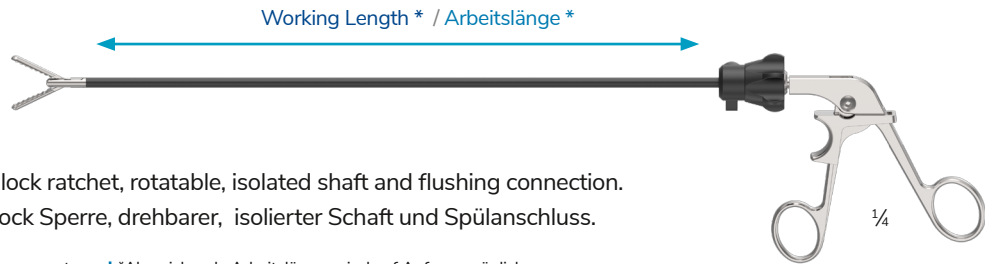



| Axial ring handle with slide lock ratchet, rotatable, isolated shaft and flushing connection.
 | Axialer Ringgriff mit Slide Lock Sperre, drehbarer, isolierter Schaft und Spülanschluss.

| *Other working lengths are available on request. | *Abweichende Arbeitslängen sind auf Anfrage möglich.



Atraumatic Grasper

Atraumatische Greifzangen

| | Description Beschreibung | Working Length Arbeitslänge | Art No. Art.-Nr. |
|--|---|--------------------------------|---------------------|
|  | Atraumatic grasper, wavy teeth with Reservoir, single action jaws Atraumatische Greifzange, gewellte Zahnung mit Reservoir, einfachbeweglich | 36 cm | PT250-36-02 |
| | | 45 cm | PT250-45-02 |
|  | Atraumatic grasper, wavy teeth with Reservoir, double action jaws Atraumatische Greifzange, gewellte Zahnung mit Reservoir, doppelbeweglich | 36 cm | PT251-36-02 |
| | | 45 cm | PT251-45-02 |

Retraction Grasper

Retraktions-Greifzangen

| | Description Beschreibung | Working Length Arbeitslänge | Art No. Art.-Nr. |
|--|--|--------------------------------|---------------------|
|  | Retraction grasper, wavy teeth, single action jaws Retraktions-Greifzange, gewellte Zahnung, einfachbeweglich | 36 cm | PT252-36-02 |
| | | 45 cm | PT252-45-02 |
|  | Retraction grasper, wavy teeth, double action jaws Retraktions-Greifzange, gewellte Zahnung, doppelbeweglich | 36 cm | PT253-36-02 |
| | | 45 cm | PT253-45-02 |



**Your focus is on people.
Our focus is on the details.**

ERGONOMICS, VERSATILITY,
ECONOMY AND QUALITY.

ERGONOMIE, VIELSEITIGKEIT, WIRT-
SCHAFTLICHKEIT UND QUALITÄT.







shaft Ø 10 mm

shaft Ø 5 mm



RETRACTORS

RETRAKTOREN

| Working Length Arbeitslänge | Art No. shaft Ø 5 mm Art.-Nr. Schaft-Ø 5 mm | Art No. shaft Ø 10 mm Art.-Nr. Schaft-Ø 10 mm | Quantity fingers Anzahl Finger | Description Beschreibung | |
|--------------------------------|--|--|---|---|---|
| 33 cm | 300-901-3505 | 300-901-3510 | 5 | Fan Retractor, spread 42 mm Fächer Retraktor, Spreizung 42 mm |  |
| 36 cm | 300-901-3605 | 300-901-3610 | | | |
| 45 cm | 300-901-4505 | 300-901-4510 | | | |
| 33 cm | 300-902-3505 | 300-902-3510 | 5 | Fan Retractor, spread 55 mm, swivelling 45° Fächer Retraktor Spreizung 55 mm, aufschwenkbar 45° |  |
| 36 cm | 300-902-3605 | 300-902-3610 | | | |
| 45 cm | 300-902-4505 | 300-902-4510 | | | |
| 33 cm | 300-903-3505 | 300-903-3510 | 3 | Fan Retractor, spread 42 mm Fächer Retraktor Spreizung 42 mm |  |
| 36 cm | 300-903-3605 | 300-903-3610 | | | |
| 45 cm | 300-903-4505 | 300-903-4510 | | | |
| 33 cm | 300-904-3505 | 300-904-3510 | 1 | Esophageal Retractor, fenestrated with 2,5 x 1,5 mm Speiseröhre-Retraktor, gefenstert mit 2,5 x 1,5 mm |  |
| 36 cm | 300-904-3605 | 300-904-3610 | | | |
| 42 cm | 300-904-4205 | 300-904-4210 | | | |
| 45 cm | 300-904-4505 | 300-904-4510 | | | |



CHOLANGIOGRAPHY Ø 5 mm

Cholangiography fixation clamp with channel
 for 6 Charrier-catheters.

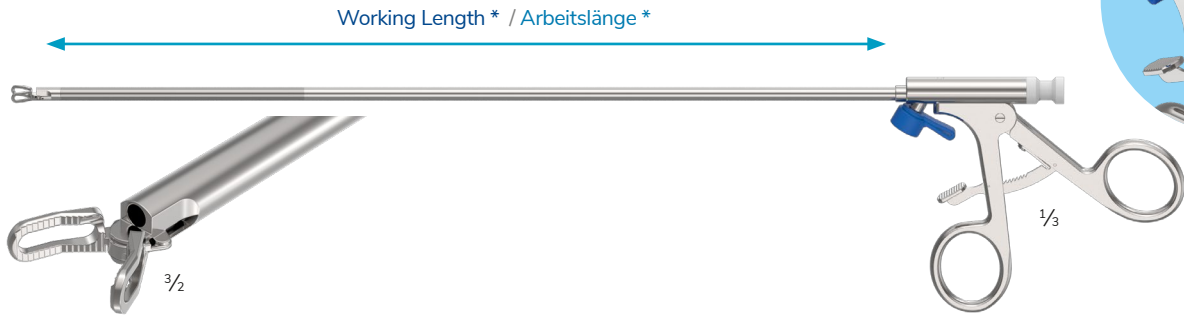

| *Other working lengths are available on request. | *Abweichende Arbeitslängen sind auf Anfrage möglich.

| Art No. Art.-Nr. | Working Length Arbeitslänge |
|---------------------|--------------------------------|
| 300-22927-05 | 33 cm |

| with flushing connection
 | mit Spülanschluss

CHOLANGIOGRAPHIE Ø 5 mm

Cholangiographie-Fixierzange mit Kanal
 für 6 Charrier-Katheter

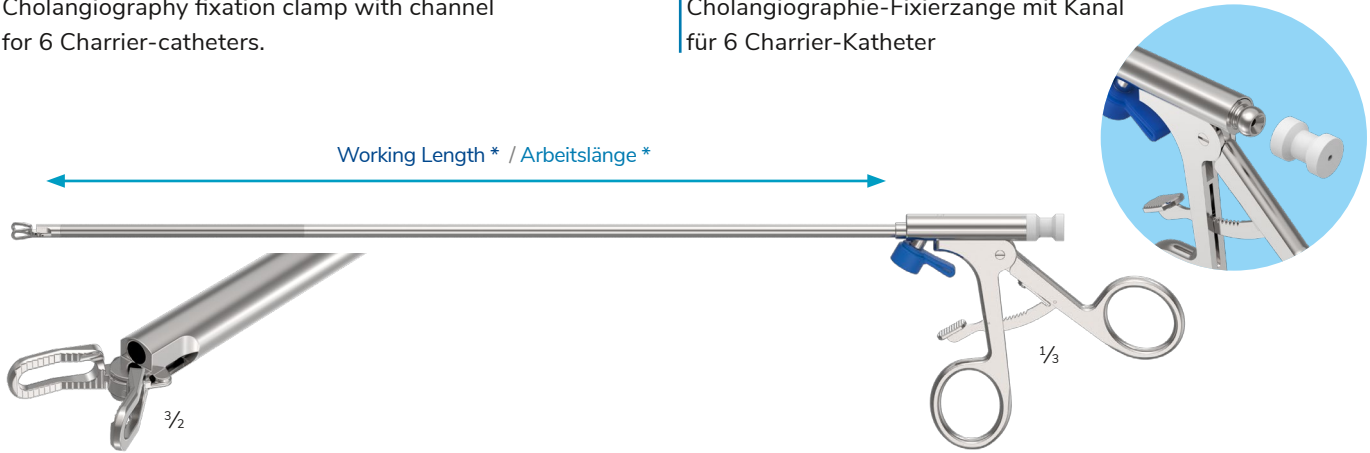

| *Other working lengths are available on request. | *Abweichende Arbeitslängen sind auf Anfrage möglich.

| Art No. Art.-Nr. | Working Length Arbeitslänge |
|---------------------|--------------------------------|
| 300-22927-05 | 33 cm |

| with flushing connection
 | mit Spülanschluss

CHOLANGIOGRAPHY Ø 5 mm

Cholangiography fixation clamp with channel
 for 6 Charrier-catheters.

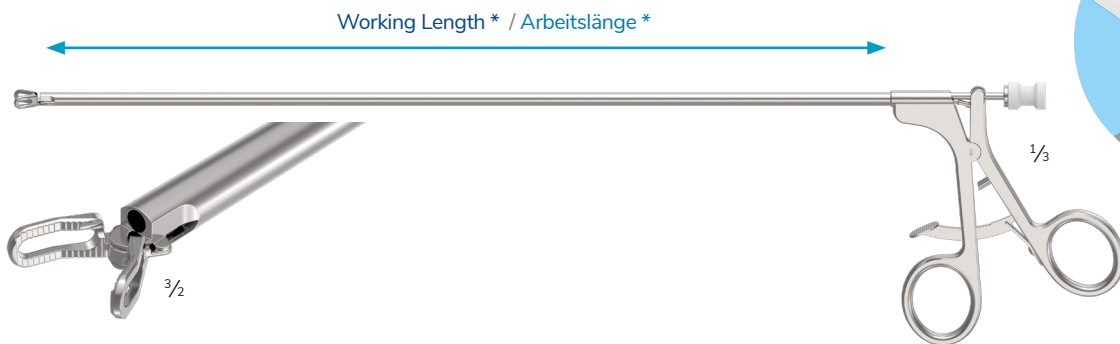

| *Other working lengths are available on request. | *Abweichende Arbeitslängen sind auf Anfrage möglich.

| Art No. Art.-Nr. | Working Length Arbeitslänge |
|---------------------|--------------------------------|
| 300-22923-05 | 33 cm |

CHOLANGIOGRAPHIE Ø 5 mm

Cholangiographie-Fixierzange mit Kanal
 für 6 Charrier-Katheter

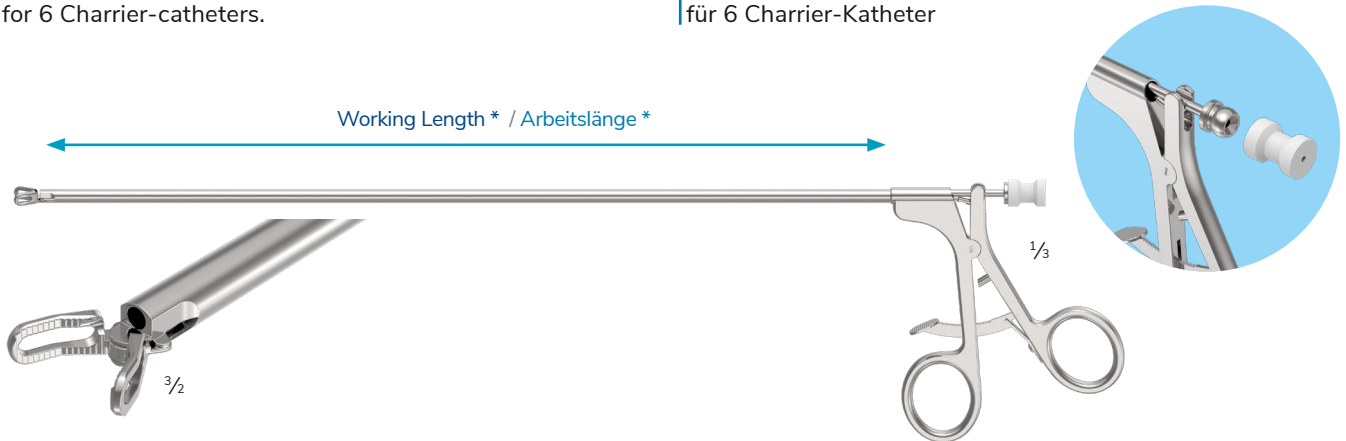

| *Other working lengths are available on request. | *Abweichende Arbeitslängen sind auf Anfrage möglich.

| Art No. Art.-Nr. | Working Length Arbeitslänge |
|---------------------|--------------------------------|
| 300-22923-05 | 33 cm |

510(k)



BEMA GmbH + Co. KG | Rudolf-Diesel-Straße 12 | D-78576 Emmingen

+49 (0) 74 65 / 92 99-0

www.bemamedical.com

+49 (0) 74 65 / 92 99-29

mail@bemamedical.com

Unser Unternehmen ist zertifiziert nach EN ISO 13485. Außerdem besteht eine Registrierung bei der FDA und 510(k) für Klasse IIb Produkte.

BEMA is certified pursuant to EN ISO 13485 and registered with the FDA and 510(k) for Class IIb products.